



**SARNAFIL® TPO - MECHANICALLY FASTENED ROOF SYSTEM
ON CONCRETE DECK WITH THERMAL INSULATION**
TECHNICAL DETAILS SF TPO – 003.

SARNAFIL® TPO - MECHANICALLY FASTENED ROOF SYSTEM ON CONCRETE DECK WITH THERMAL INSULATION

NUMBERING OF DETAILS

SF TPO - 003.00.01

Membrane Technologies

SF TPO -	Sarnafil® TPO
SF PVC -	Sarnafil® PVC
SPL TPO -	Sikaplan® TPO
SPL PVC -	Sikaplan® PVC
SB T -	SikaBit® T

Roofing Systems

001.	Mechanically Fastened Roof System on Metal Deck with Thermal Insulation
002.	Mechanically Fastened Roof System on Wood Deck with Thermal Insulation
003.	Mechanically Fastened Roof System on Concrete Deck with Thermal Insulation
004.	Mechanically Fastened Roof System on Wood Deck without Thermal Insulation
005.	Mechanically Fastened Roof System on Concrete Deck without Thermal Insulation
020.	Gravel Ballasted Roof System on Concrete Deck with Thermal Insulation
021.	Gravel Ballasted Roof System on Concrete Deck without Thermal Insulation
030.	Inverted Roof System, Loose Laid Membrane on Concrete Deck with Paving Slabs
031.	Inverted Roof System, Loose Laid Membrane on Concrete Deck with Green Roof System
032.	Inverted Roof System, Adhered Membrane on Concrete Deck with Paving Slabs
033.	Inverted Roof System, Adhered Membrane on Concrete Deck with Green Roof System
040.	Utility Roof System on Concrete Deck with Thermal Insulation and Paving Slabs
041.	Utility Roof System on Concrete Deck without Thermal Insulation and Paving Slabs
050.	Green Roof System - Extensive on Concrete Deck with Thermal Insulation
051.	Green Roof System - Intensive on Concrete Deck with Thermal Insulation
060.	Adhered Roof System on Concrete Deck with Thermal Insulation
061.	Adhered Roof System on Concrete Deck without Thermal Insulation
100.	Fully Torched System to a Cement Mortar Layer on Concrete Deck with Thermal Insulation
101.	Fully Torched System on Concrete Deck without Thermal Insulation

01

Variants

00.	Build-up	Details
01.	Parapet	
02.	Roof Edge Termination	
03.	Upstand	
04.	Skylight	
05.	Roof Drain (Outlet)	
06.	Scupper	
07.	Overflow	
08.	Vent Pipe / Post	
09.	Gutter	
10.	Movement Joint	
11.	Penetration	
12.	Foundation	
13.	Various	

SARNAFIL® TPO - MECHANICALLY FASTENED ROOF SYSTEM ON CONCRETE DECK WITH THERMAL INSULATION

LIST OF DETAILS

SF TPO - 003.00.01 - Build-up - Sarnafast® Tube Spot Fastening System

SF TPO - 003.00.02 - Build-up - Sarnafast® Spot Fastening System

SF TPO - 003.01.01 - Parapet - Sarnafil® T Metal Sheet - Mechanically Fastened on Concrete Parapet

SF TPO - 003.01.02 - Parapet - Sarnafil® T Metal Sheet - Adhered on Concrete Parapet

SF TPO - 003.01.03 - Parapet - Metal Capping - Mechanically Fastened on Concrete Parapet

SF TPO - 003.01.04 - Parapet - Metal Capping - Adhered on Concrete Parapet

SF TPO - 003.02.01 - Roof Edge Termination with Gutter

SF TPO - 003.03.01 - Upstand - Sarnafil® T Metal Sheet - Mechanically Fastened on Concrete Wall

SF TPO - 003.03.02 - Upstand - Sarnafil® T Metal Sheet - Adhered on Concrete Wall

SF TPO - 003.03.03 - Upstand - Counter Flashing - Adhered on Concrete Wall

SF TPO - 003.04.01 - Skylight - Sealed - Mechanically Fastened on Skylight System

SF TPO - 003.04.02 - Skylight - Sealed - Adhered on Skylight System

SF TPO - 003.04.03 - Skylight - Clamped - Mechanically Fastened on Skylight System

SF TPO - 003.04.04 - Skylight - Clamped - Adhered on Skylight System

SF TPO - 003.05.01 - Roof Drain (Outlet)

SF TPO - 003.06.01 - Scupper - Mechanically Fastened on Concrete Wall

SF TPO - 003.06.02 - Scupper - Adhered on Concrete Wall

SF TPO - 003.07.01 - Overflow - Mechanically Fastened on Concrete Wall

SF TPO - 003.07.02 - Overflow - Adhered on Concrete Wall

SF TPO - 003.08.01 - Vent Pipe / Post

SF TPO - 003.09.01 - Gutter

SF TPO - 003.10.01 - Movement Joint

Sarnafast® Fasteners and Tubes, thermal insulation fastening

Sarnafil® TS 77 membrane, mechanically fastened

S-Glass Fleece-120 separation layer,
fire protection layer (if required)

Sikatherm® / Sarnatherm®,
thermal insulation

Sarnavap® vapour control layer
(positioning according to local
climate conditions and regulations)

- 1 Substrate side
- 2 Membrane side

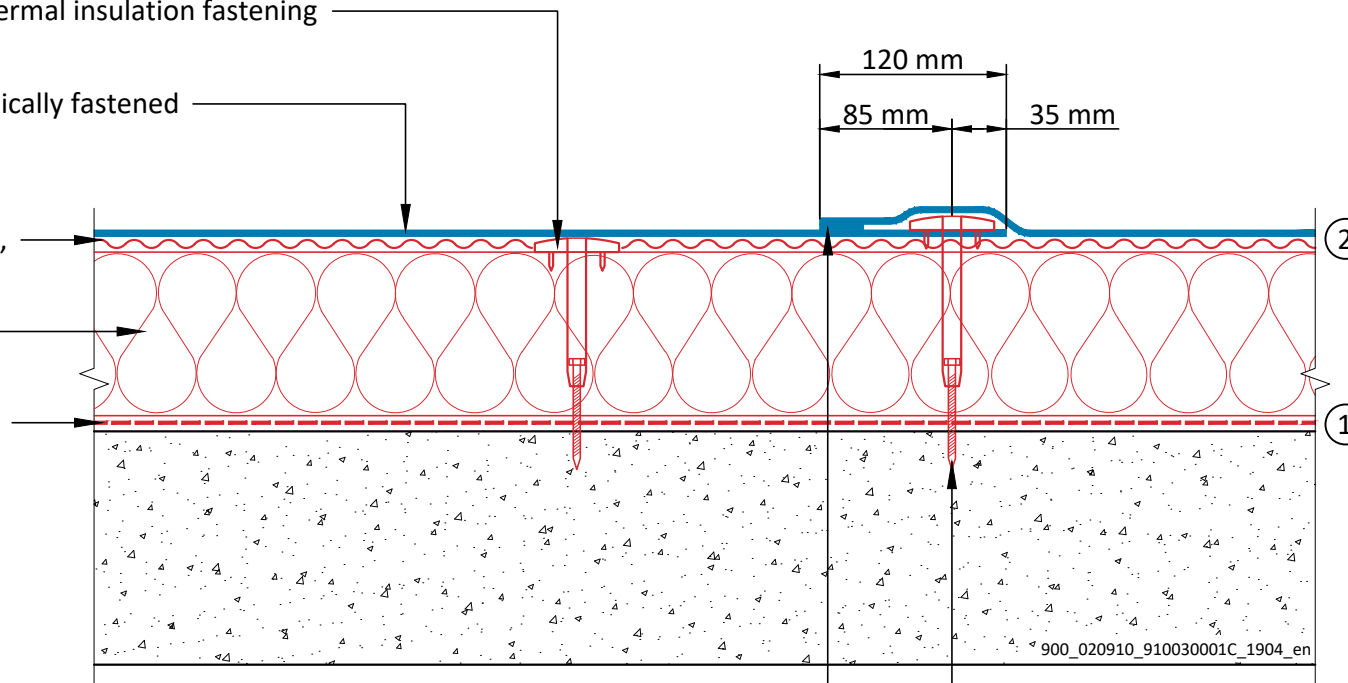

Sarnafast® Fasteners and Washers, membrane fastening

Hot-air weld

Sarnabar® Tube Perimeter Securement

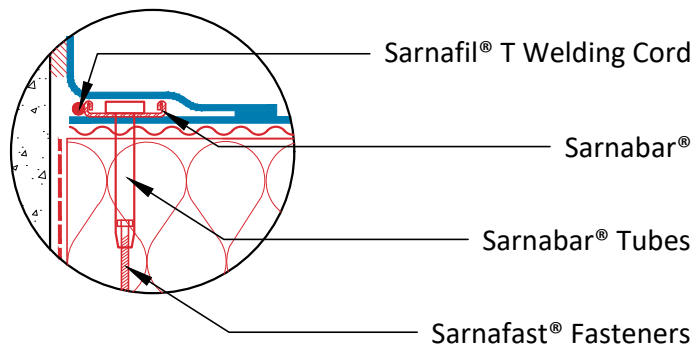

Sarnafil® T Welding Cord

Sarnabar®

Sarnabar® Tubes

Sarnafast® Fasteners

All flashings, terminations and penetrations wider than
500 mm must be secured mechanically using Sarnabar®.

900_020910_910030001C_1904_en

**SARNAFIL® TPO - MECHANICALLY FASTENED ROOF SYSTEM
ON CONCRETE DECK WITH THERMAL INSULATION**

SF TPO - 003.00.01 - Build-up - Sarnafast® Tube Spot Fastening System

Sika General Detail. Template for translation.

900_020910_910030001C_1904_en
April 2019

Sika Services AG

Tüffenwies 16
8048 Zürich
Switzerland

Tel: +41 584364040

www.sika.com

BUILDING TRUST



DRAWING MUST ALWAYS BE REVIEWED BY A DESIGN SPECIALIST AND IF NECESSARY MODIFIED TO ENSURE SUITABILITY FOR THE SPECIFIC APPLICATION

The information contained herein and any other advice are given in good faith based on Sika's current knowledge and experience of the products when properly stored, handled and applied under normal conditions in accordance with Sika's recommendations. The information only applies to the application(s) and product(s) expressly referred to herein and is based on laboratory tests which do not replace practical tests. In case of changes in the parameters of the application, such as changes in substrates etc., or in case of a different application, consult Sika's Technical Service prior to using Sika products. The information contained herein does not relieve the user of the products from testing them for the intended application and purpose. All orders are accepted subject to our current terms of sale and delivery. Users must always refer to the most recent issue of the local Product Data Sheet for the product concerned, copies of which will be supplied on request.

Sarnafast® Fasteners and Washers, thermal insulation fastening

Sarnafil® TS 77 membrane, mechanically fastened

S-Glass Fleece-120 separation layer,
fire protection layer (if required)

Sikatherm® / Sarnatherm®,
thermal insulation

Sarnavap® vapour control layer
(positioning according to local
climate conditions and regulations)

- 1 Substrate side
- 2 Membrane side

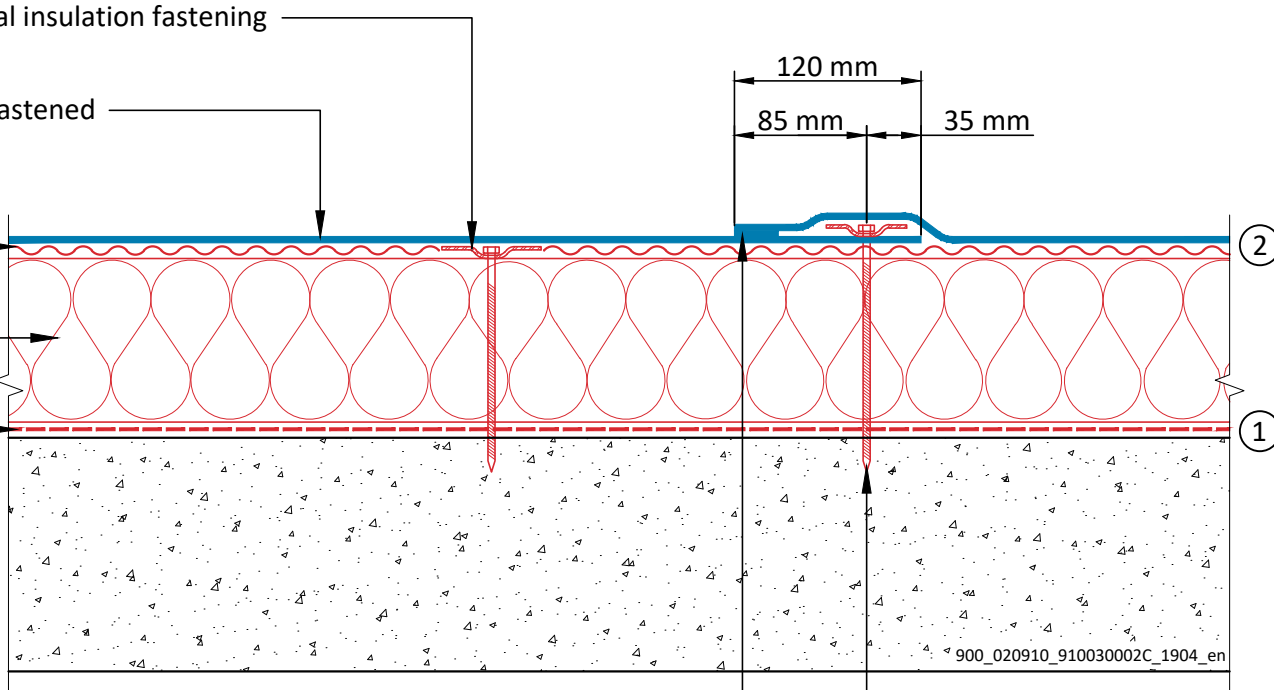

Sarnabar® Perimeter Securement

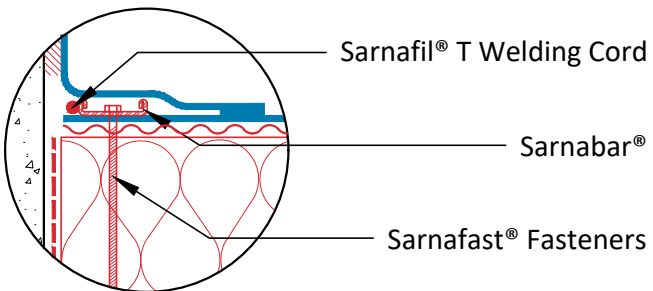

Sarnafast® Fasteners and Washers, membrane fastening

Hot-air weld

All flashings, terminations and penetrations wider than 500 mm must be secured mechanically using Sarnabar®.

**SARNAFIL® TPO - MECHANICALLY FASTENED ROOF SYSTEM
ON CONCRETE DECK WITH THERMAL INSULATION**

SF TPO - 003.00.02 - Build-up - Sarnafast® Spot Fastening System

Sika General Detail. Template for translation.

900_020910_910030002C_1904_en
April 2019

Sika Services AG

Tüffenwies 16
8048 Zürich
Switzerland

Tel: +41 584364040

www.sika.com

BUILDING TRUST



DRAWING MUST ALWAYS BE REVIEWED BY A DESIGN SPECIALIST AND IF NECESSARY MODIFIED TO ENSURE SUITABILITY FOR THE SPECIFIC APPLICATION

The information contained herein and any other advice are given in good faith based on Sika's current knowledge and experience of the products when properly stored, handled and applied under normal conditions in accordance with Sika's recommendations. The information only applies to the application(s) and product(s) expressly referred to herein and is based on laboratory tests which do not replace practical tests. In case of changes in the parameters of the application, such as changes in substrates etc., or in case of a different application, consult Sika's Technical Service prior to using Sika products. The information contained herein does not relieve the user of the products from testing them for the intended application and purpose. All orders are accepted subject to our current terms of sale and delivery. Users must always refer to the most recent issue of the local Product Data Sheet for the product concerned, copies of which will be supplied on request.

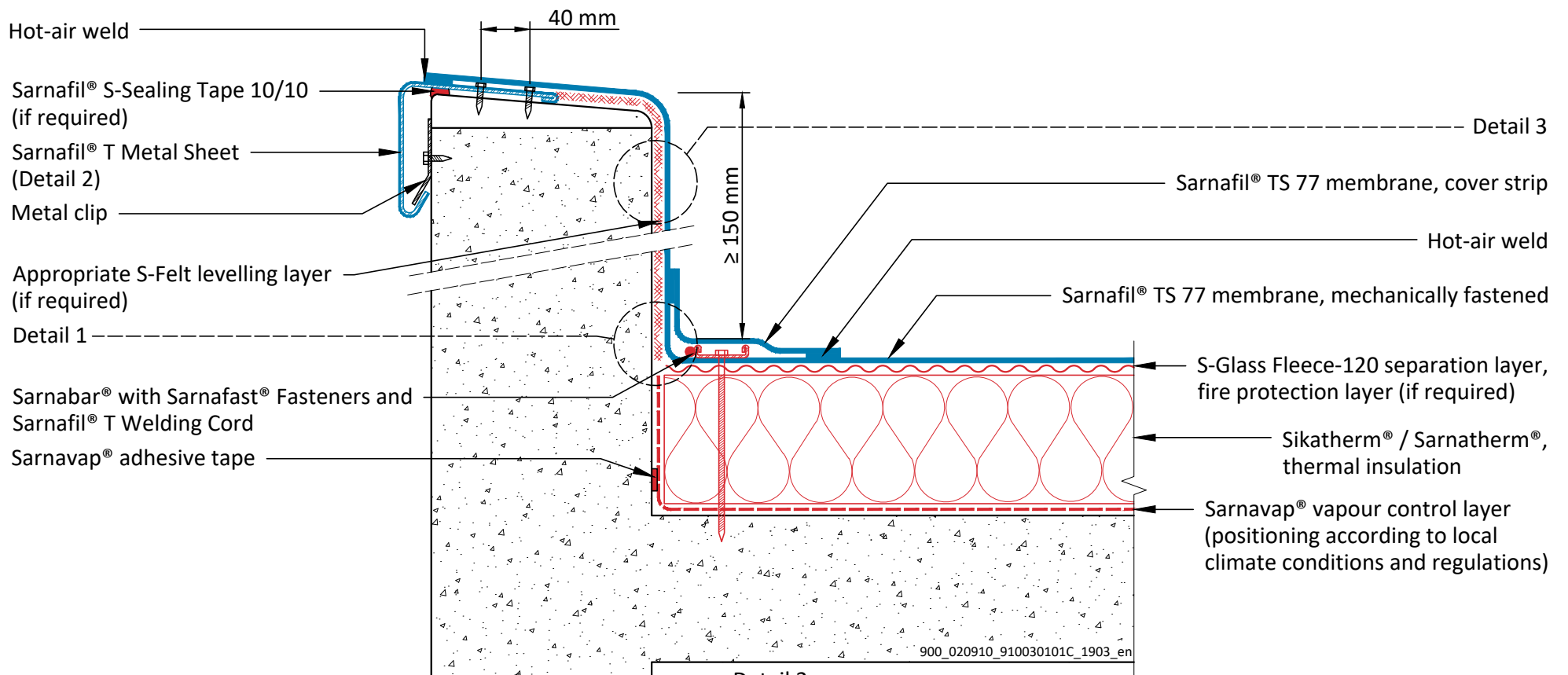

Detail 1
Sarnabar® Perimeter
Securement Vertical (Alternative)

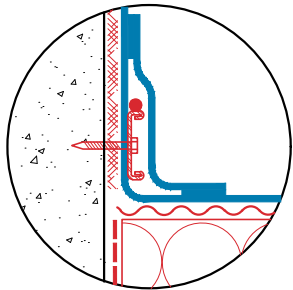

Detail 2
Sarnafil® T Metal Sheet Fastening

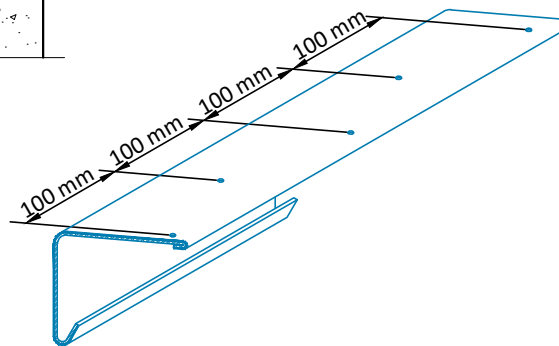

Detail 3
Additional Fastening for
Parapet Height > 800 mm

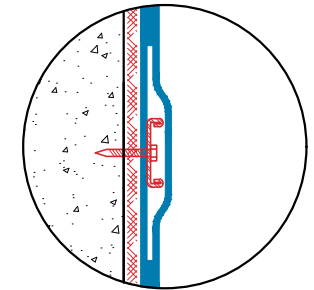

**SARNAFIL® TPO - MECHANICALLY FASTENED ROOF SYSTEM
ON CONCRETE DECK WITH THERMAL INSULATION**

SF TPO - 003.01.01 - Parapet - Sarnafil® T Metal Sheet - Mechanically Fastened on Concrete Parapet

Sika General Detail. Template for translation.

900_020910_910030101C_1903_en
March 2019

Sika Services AG

Tüffenwies 16
8048 Zürich
Switzerland

Tel: +41 584364040

www.sika.com

BUILDING TRUST



DRAWING MUST ALWAYS BE REVIEWED BY A DESIGN SPECIALIST AND IF NECESSARY MODIFIED TO ENSURE SUITABILITY FOR THE SPECIFIC APPLICATION

The information contained herein and any other advice are given in good faith based on Sika's current knowledge and experience of the products when properly stored, handled and applied under normal conditions in accordance with Sika's recommendations. The information only applies to the application(s) and product(s) expressly referred to herein and is based on laboratory tests which do not replace practical tests. In case of changes in the parameters of the application, such as changes in substrates etc., or in case of a different application, consult Sika's Technical Service prior to using Sika products. The information contained herein does not relieve the user of the products from testing them for the intended application and purpose. All orders are accepted subject to our current terms of sale and delivery. Users must always refer to the most recent issue of the local Product Data Sheet for the product concerned, copies of which will be supplied on request.

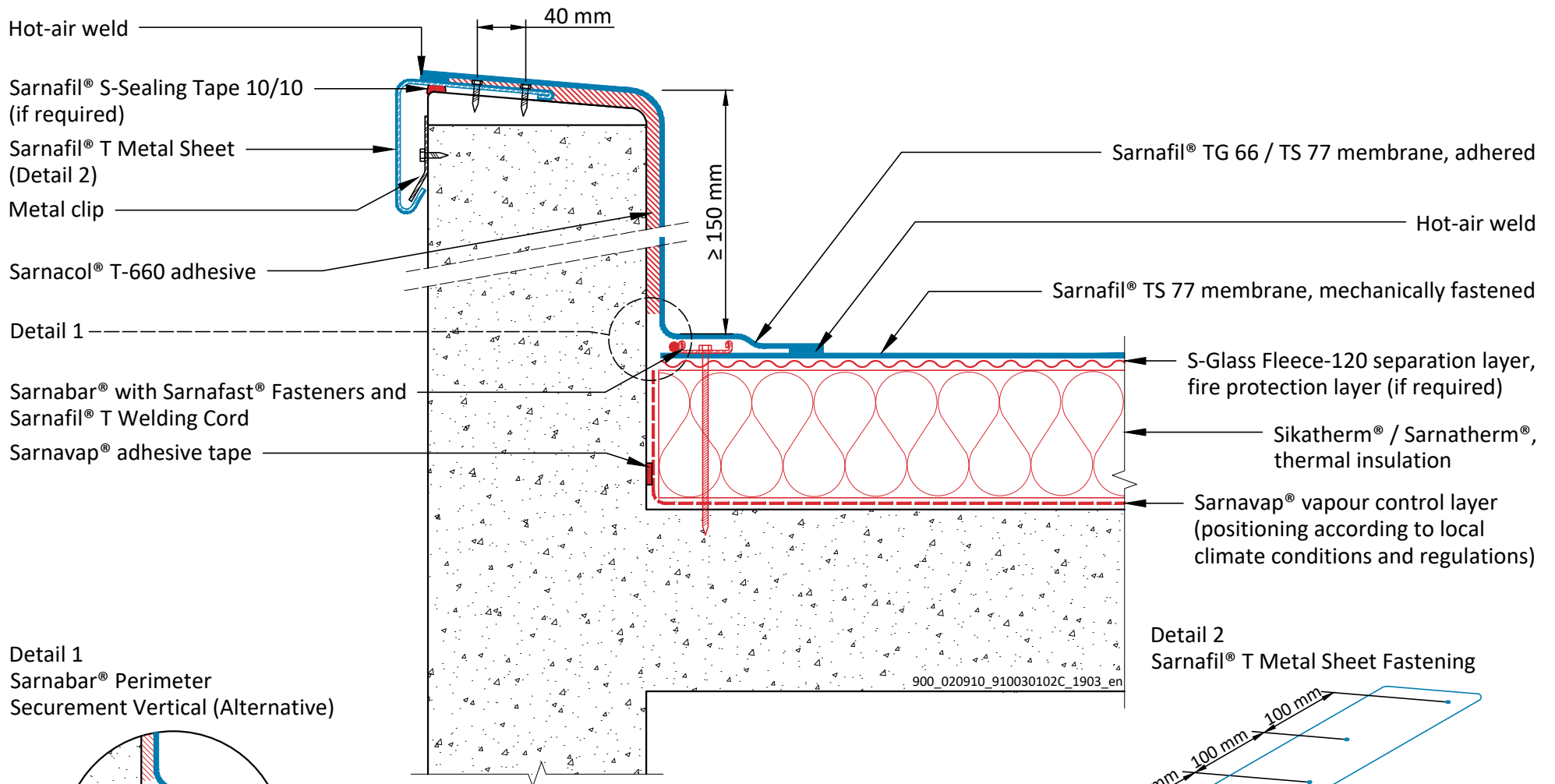

Detail 1
Sarnabar® Perimeter
Securement Vertical (Alternative)

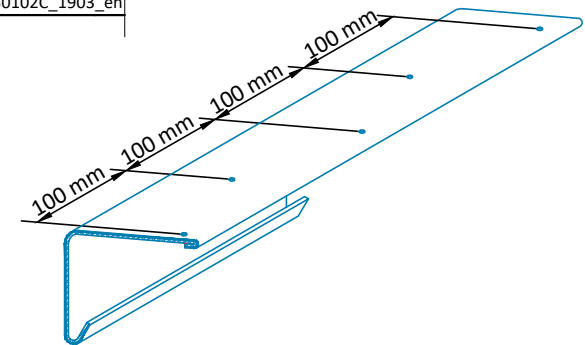
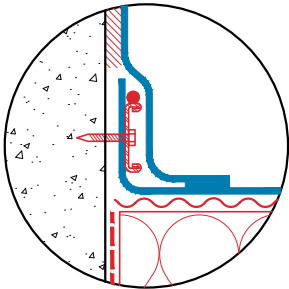

**SARNAFIL® TPO - MECHANICALLY FASTENED ROOF SYSTEM
ON CONCRETE DECK WITH THERMAL INSULATION**

SF TPO - 003.01.02 - Parapet - Sarnafil® T Metal Sheet - Adhered on Concrete Parapet

Sika General Detail. Template for translation.

900_020910_910030102C_1903_en
March 2019

Sika Services AG

Tüffenwies 16
8048 Zürich
Switzerland

Tel: +41 584364040

www.sika.com

BUILDING TRUST



DRAWING MUST ALWAYS BE REVIEWED BY A DESIGN SPECIALIST AND IF NECESSARY MODIFIED TO ENSURE SUITABILITY FOR THE SPECIFIC APPLICATION

The information contained herein and any other advice are given in good faith based on Sika's current knowledge and experience of the products when properly stored, handled and applied under normal conditions in accordance with Sika's recommendations. The information only applies to the application(s) and product(s) expressly referred to herein and is based on laboratory tests which do not replace practical tests. In case of changes in the parameters of the application, such as changes in substrates etc., or in case of a different application, consult Sika's Technical Service prior to using Sika products. The information contained herein does not relieve the user of the products from testing them for the intended application and purpose. All orders are accepted subject to our current terms of sale and delivery. Users must always refer to the most recent issue of the local Product Data Sheet for the product concerned, copies of which will be supplied on request.

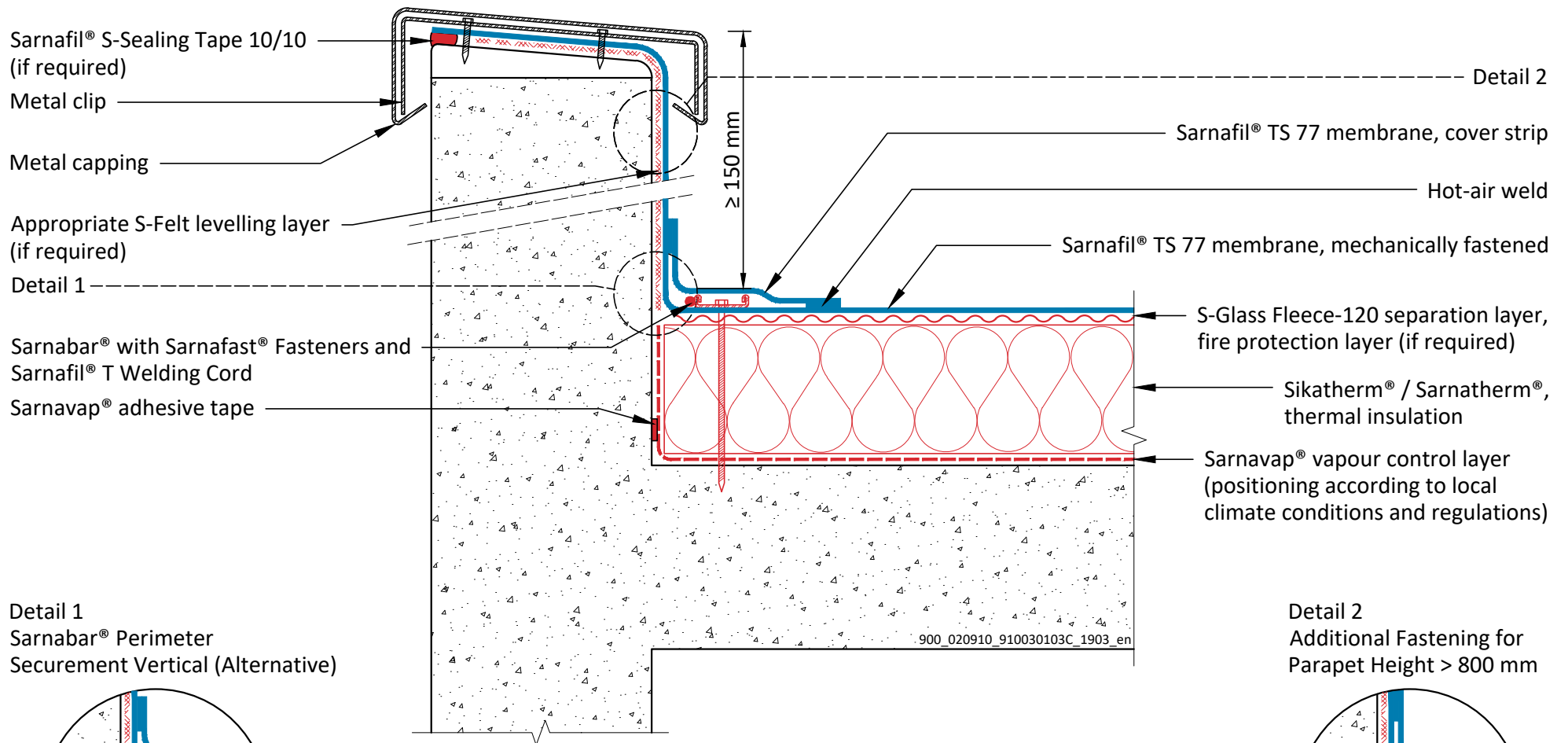

Sarnafil® S-Sealing Tape 10/10
(if required)

Metal clip

Metal capping

Appropriate S-Felt levelling layer
(if required)

Detail 1

Sarnabar® with Sarnafast® Fasteners and
Sarnafil® T Welding Cord

Sarnavap® adhesive tape

≥ 150 mm

Sarnafil® TS 77 membrane, cover strip

Hot-air weld

Sarnafil® TS 77 membrane, mechanically fastened

S-Glass Fleece-120 separation layer,
fire protection layer (if required)

Sikatherm® / Sarnatherm®,
thermal insulation

Sarnavap® vapour control layer
(positioning according to local
climate conditions and regulations)

Detail 1

Sarnabar® Perimeter
Securement Vertical (Alternative)

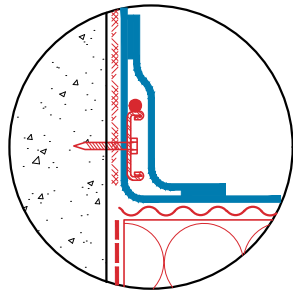

900_020910_910030103C_1903_en

Detail 2

Additional Fastening for
Parapet Height > 800 mm

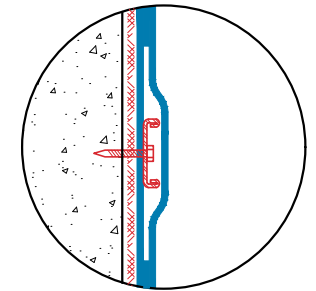

**SARNAFIL® TPO - MECHANICALLY FASTENED ROOF SYSTEM
ON CONCRETE DECK WITH THERMAL INSULATION**
SF TPO - 003.01.03 - Parapet - Metal Capping - Mechanically Fastened on Concrete Parapet
Sika General Detail. Template for translation.

900_020910_910030103C_1903_en
March 2019

Sika Services AG
Tüffenwies 16
8048 Zürich
Switzerland
Tel: +41 584364040
www.sika.com

BUILDING TRUST



DRAWING MUST ALWAYS BE REVIEWED BY A DESIGN SPECIALIST AND IF NECESSARY MODIFIED TO ENSURE SUITABILITY FOR THE SPECIFIC APPLICATION
The information contained herein and any other advice are given in good faith based on Sika's current knowledge and experience of the products when properly stored, handled and applied under normal conditions in accordance with Sika's recommendations. The information only applies to the application(s) and product(s) expressly referred to herein and is based on laboratory tests which do not replace practical tests. In case of changes in the parameters of the application, such as changes in substrates etc., or in case of a different application, consult Sika's Technical Service prior to using Sika products. The information contained herein does not relieve the user of the products from testing them for the intended application and purpose. All orders are accepted subject to our current terms of sale and delivery. Users must always refer to the most recent issue of the local Product Data Sheet for the product concerned, copies of which will be supplied on request.

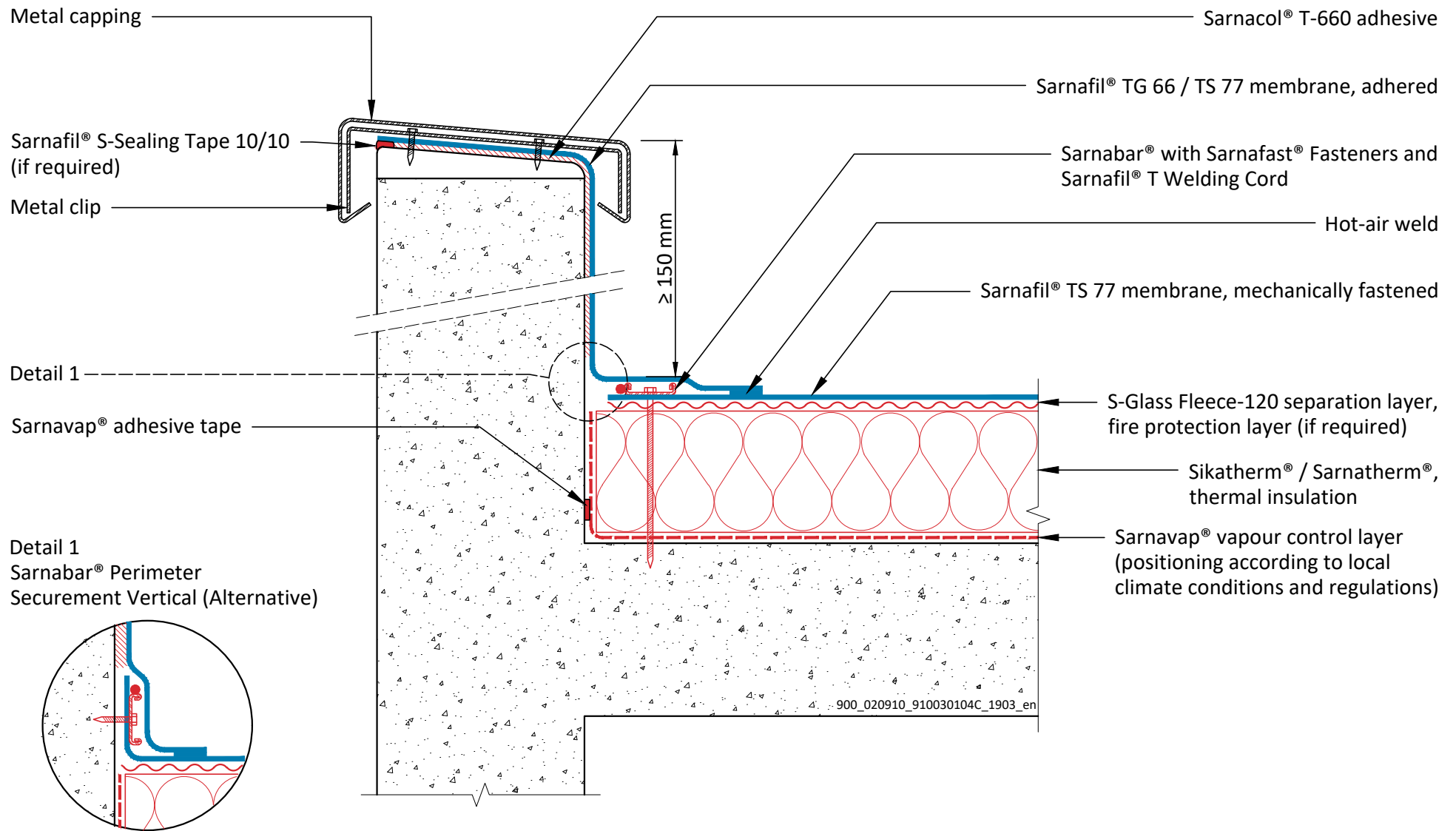

**SARNAFIL® TPO - MECHANICALLY FASTENED ROOF SYSTEM
ON CONCRETE DECK WITH THERMAL INSULATION**
SF TPO - 003.01.04 - Parapet - Metal Capping - Adhered on Concrete Parapet
Sika General Detail. Template for translation.

900_020910_910030104C_1903_en
March 2019

Sika Services AG
Tüffenwies 16
8048 Zürich
Switzerland
Tel: +41 584364040
www.sika.com

BUILDING TRUST



DRAWING MUST ALWAYS BE REVIEWED BY A DESIGN SPECIALIST AND IF NECESSARY MODIFIED TO ENSURE SUITABILITY FOR THE SPECIFIC APPLICATION

The information contained herein and any other advice are given in good faith based on Sika's current knowledge and experience of the products when properly stored, handled and applied under normal conditions in accordance with Sika's recommendations. The information only applies to the application(s) and product(s) expressly referred to herein and is based on laboratory tests which do not replace practical tests. In case of changes in the parameters of the application, such as changes in substrates etc., or in case of a different application, consult Sika's Technical Service prior to using Sika products. The information contained herein does not relieve the user of the products from testing them for the intended application and purpose. All orders are accepted subject to our current terms of sale and delivery. Users must always refer to the most recent issue of the local Product Data Sheet for the product concerned, copies of which will be supplied on request.

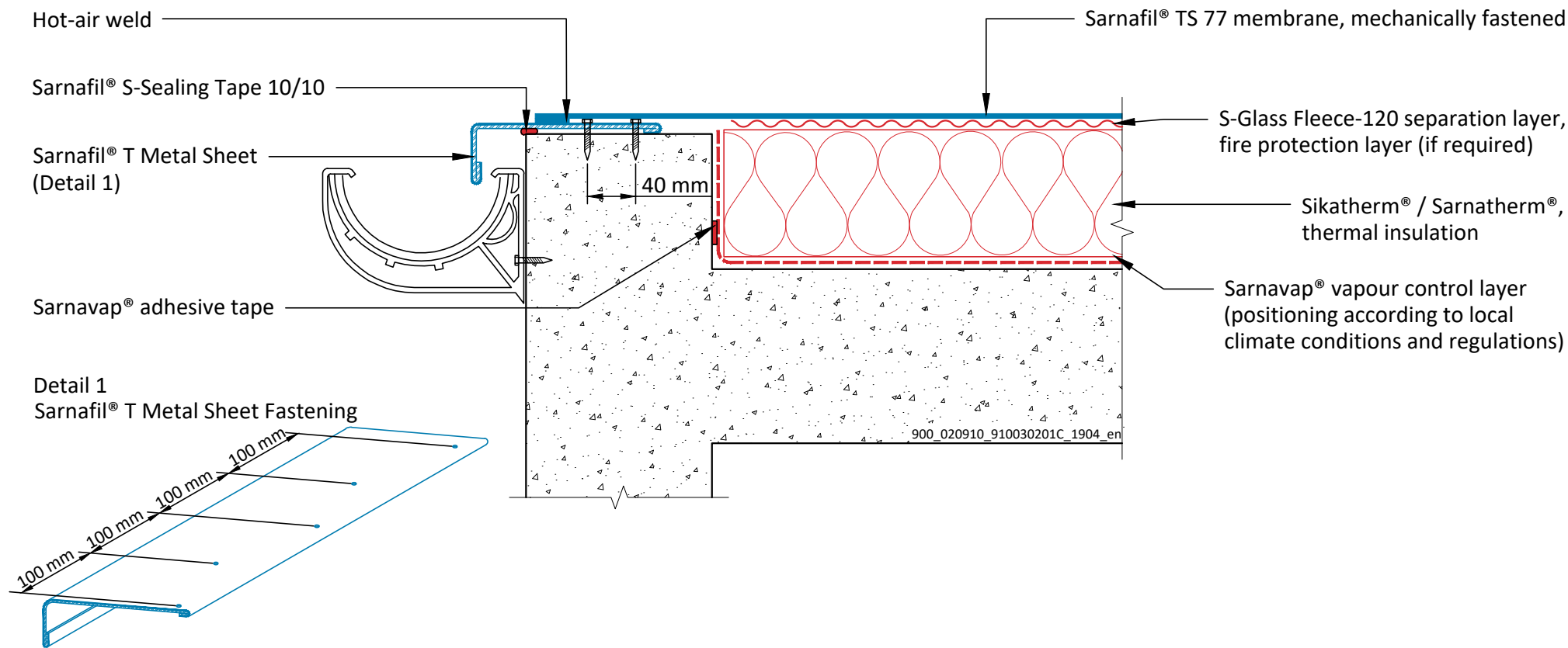

**SARNAFIL® TPO - MECHANICALLY FASTENED ROOF SYSTEM
ON CONCRETE DECK WITH THERMAL INSULATION**

SF TPO - 003.02.01 - Roof Edge Termination with Gutter

Sika General Detail. Template for translation.

900_020910_910030201C_1904_en
April 2019

Sika Services AG

Tüffenwies 16
8048 Zürich
Switzerland

Tel: +41 584364040

www.sika.com

BUILDING TRUST



DRAWING MUST ALWAYS BE REVIEWED BY A DESIGN SPECIALIST AND IF NECESSARY MODIFIED TO ENSURE SUITABILITY FOR THE SPECIFIC APPLICATION

The information contained herein and any other advice are given in good faith based on Sika's current knowledge and experience of the products when properly stored, handled and applied under normal conditions in accordance with Sika's recommendations. The information only applies to the application(s) and product(s) expressly referred to herein and is based on laboratory tests which do not replace practical tests. In case of changes in the parameters of the application, such as changes in substrates etc., or in case of a different application, consult Sika's Technical Service prior to using Sika products. The information contained herein does not relieve the user of the products from testing them for the intended application and purpose. All orders are accepted subject to our current terms of sale and delivery. Users must always refer to the most recent issue of the local Product Data Sheet for the product concerned, copies of which will be supplied on request.

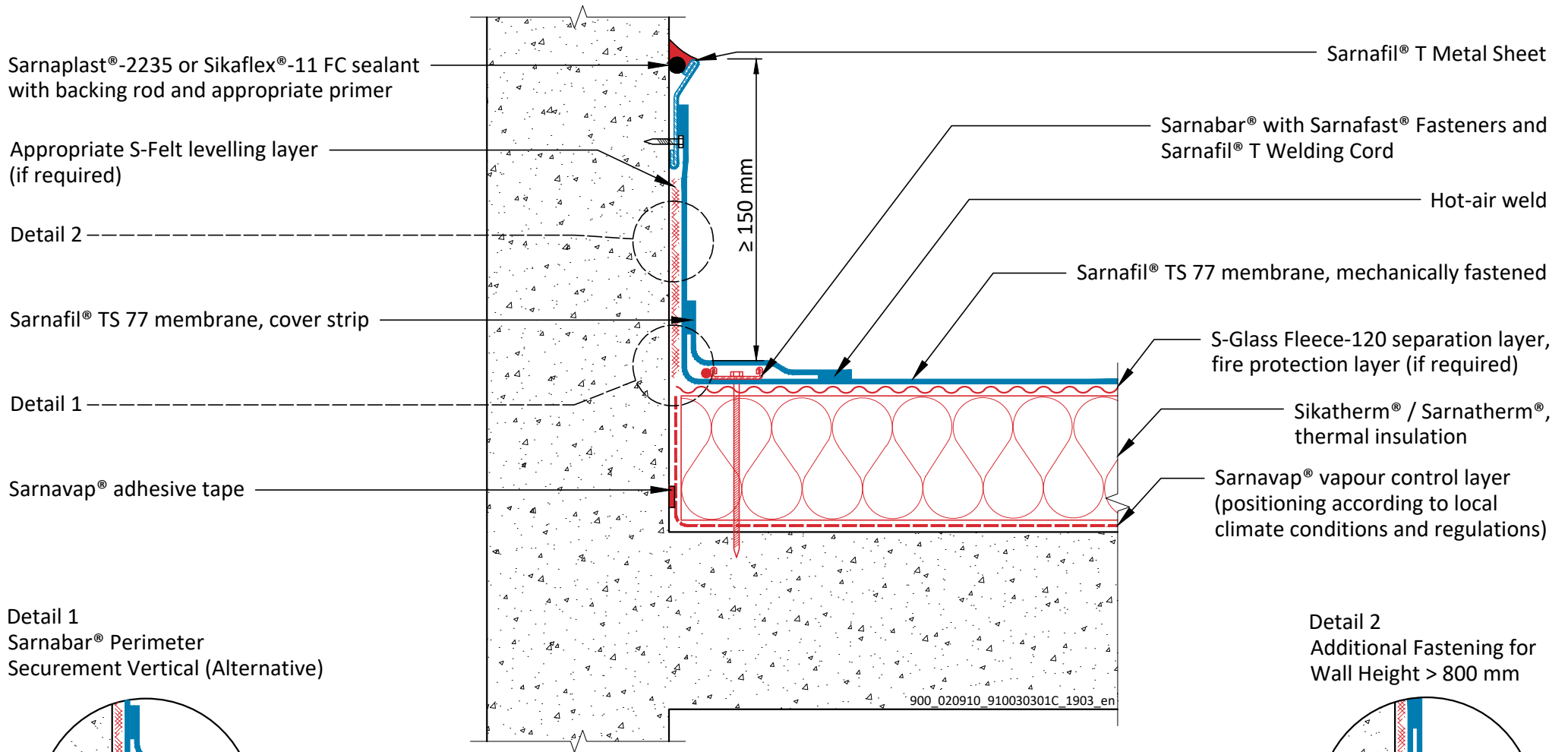

Detail 1
Sarnabar® Perimeter
Securement Vertical (Alternative)

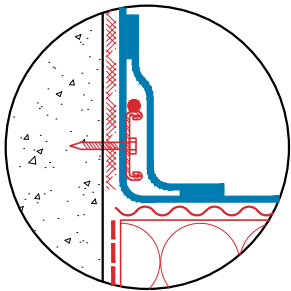

Detail 2
Additional Fastening for
Wall Height > 800 mm

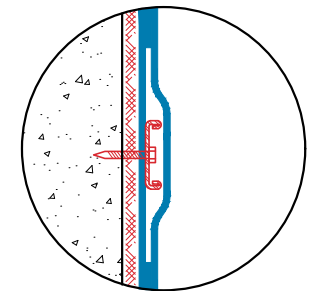

900_020910_910030301C_1903_en

**SARNAFIL® TPO - MECHANICALLY FASTENED ROOF SYSTEM
ON CONCRETE DECK WITH THERMAL INSULATION**

SF TPO - 003.03.01 - Upstand - Sarnafil® T Metal Sheet - Mechanically Fastened on Concrete Wall

Sika General Detail. Template for translation.

900_020910_910030301C_1903_en
March 2019

Sika Services AG

Tüffenwies 16
8048 Zürich
Switzerland

Tel: +41 584364040

www.sika.com

BUILDING TRUST



DRAWING MUST ALWAYS BE REVIEWED BY A DESIGN SPECIALIST AND IF NECESSARY MODIFIED TO ENSURE SUITABILITY FOR THE SPECIFIC APPLICATION

The information contained herein and any other advice are given in good faith based on Sika's current knowledge and experience of the products when properly stored, handled and applied under normal conditions in accordance with Sika's recommendations. The information only applies to the application(s) and product(s) expressly referred to herein and is based on laboratory tests which do not replace practical tests. In case of changes in the parameters of the application, such as changes in substrates etc., or in case of a different application, consult Sika's Technical Service prior to using Sika products. The information contained herein does not relieve the user of the products from testing them for the intended application and purpose. All orders are accepted subject to our current terms of sale and delivery. Users must always refer to the most recent issue of the local Product Data Sheet for the product concerned, copies of which will be supplied on request.

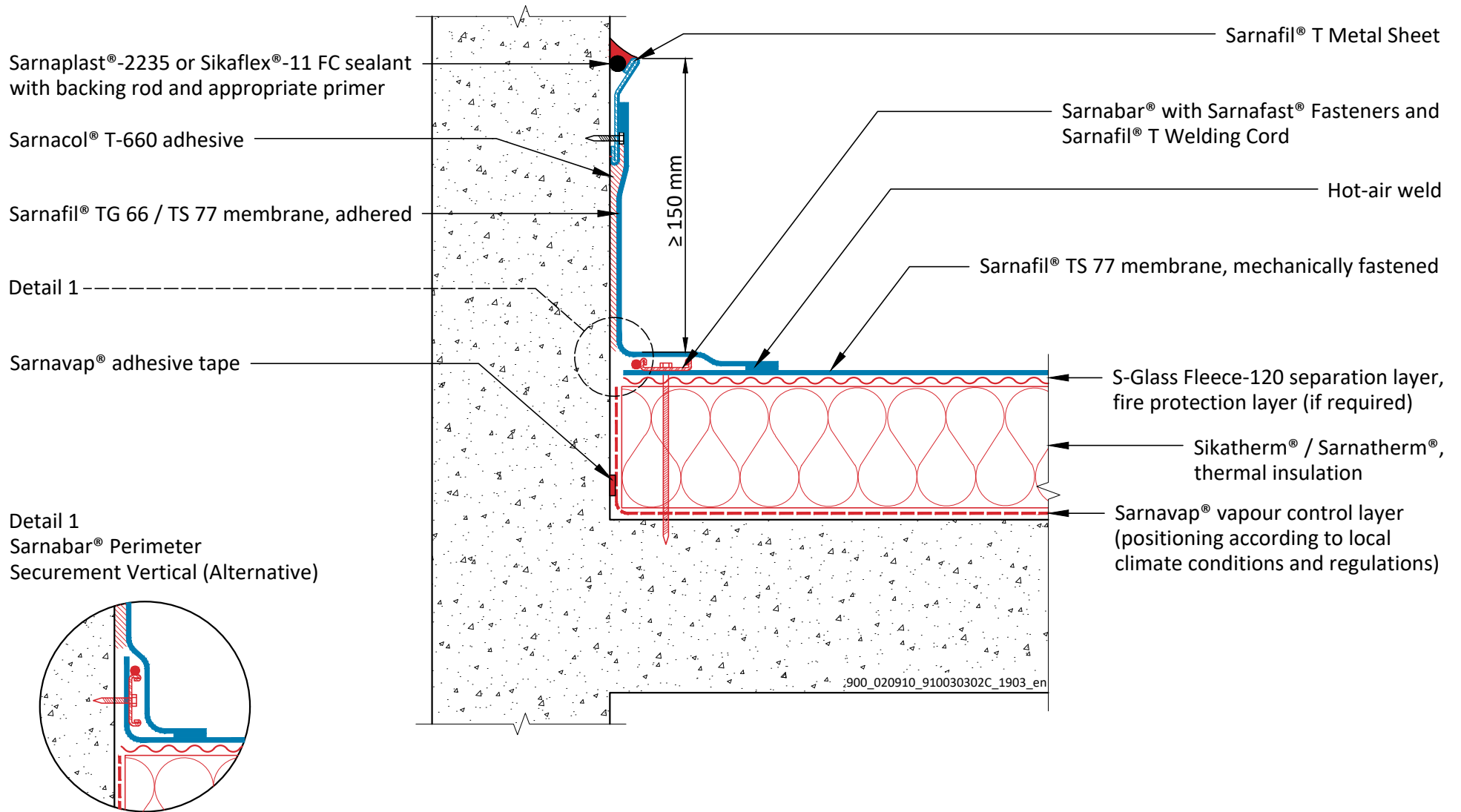

**SARNAFIL® TPO - MECHANICALLY FASTENED ROOF SYSTEM
ON CONCRETE DECK WITH THERMAL INSULATION**

SF TPO - 003.03.02 - Upstand - Sarnafil® T Metal Sheet - Adhered on Concrete Wall

Sika General Detail. Template for translation.

900_020910_910030302C_1903_en
March 2019

Sika Services AG

Tüffenwies 16
8048 Zürich
Switzerland

Tel: +41 584364040

www.sika.com

BUILDING TRUST



DRAWING MUST ALWAYS BE REVIEWED BY A DESIGN SPECIALIST AND IF NECESSARY MODIFIED TO ENSURE SUITABILITY FOR THE SPECIFIC APPLICATION

The information contained herein and any other advice are given in good faith based on Sika's current knowledge and experience of the products when properly stored, handled and applied under normal conditions in accordance with Sika's recommendations. The information only applies to the application(s) and product(s) expressly referred to herein and is based on laboratory tests which do not replace practical tests. In case of changes in the parameters of the application, such as changes in substrates etc., or in case of a different application, consult Sika's Technical Service prior to using Sika products. The information contained herein does not relieve the user of the products from testing them for the intended application and purpose. All orders are accepted subject to our current terms of sale and delivery. Users must always refer to the most recent issue of the local Product Data Sheet for the product concerned, copies of which will be supplied on request.

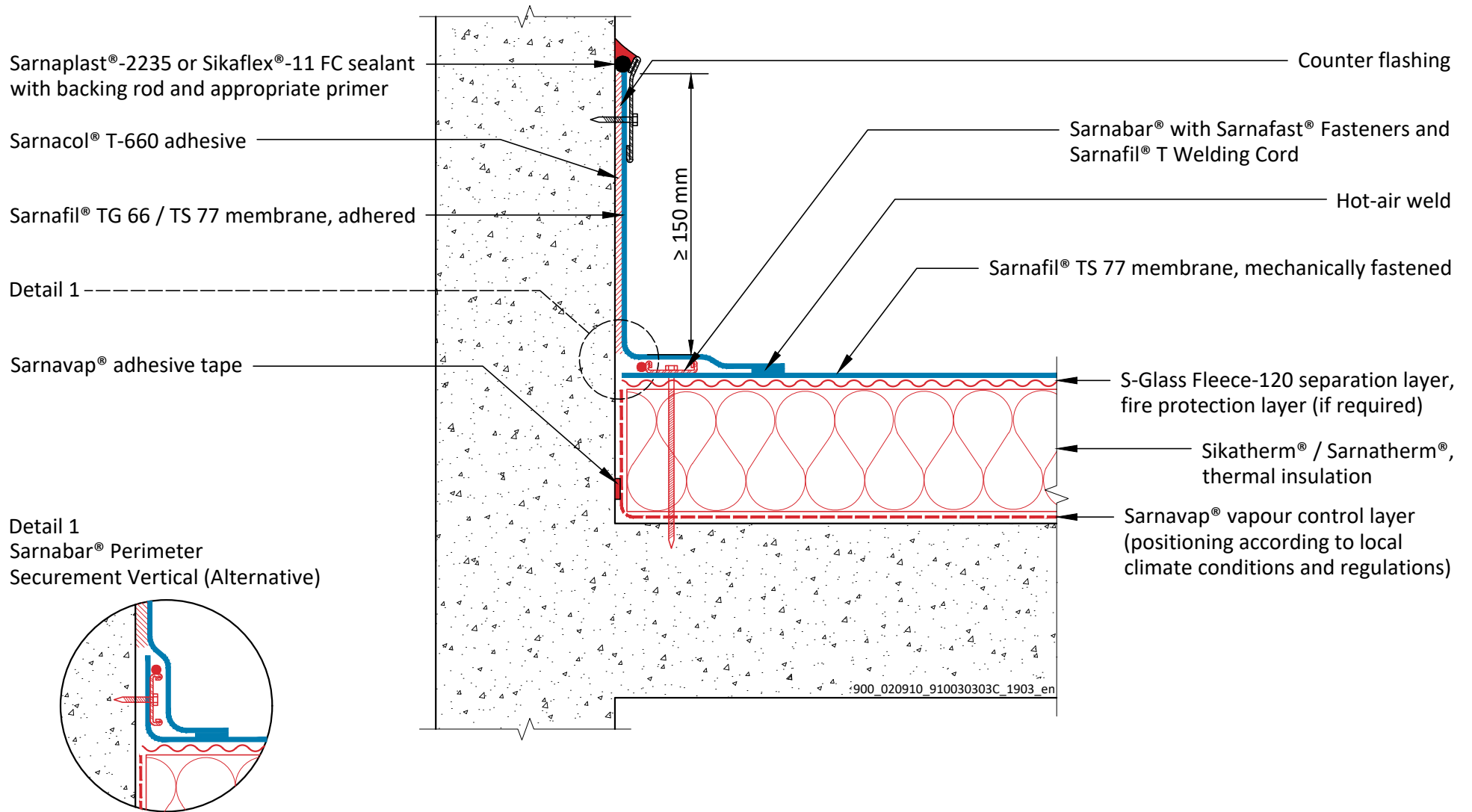

**SARNAFIL® TPO - MECHANICALLY FASTENED ROOF SYSTEM
ON CONCRETE DECK WITH THERMAL INSULATION**

SF TPO - 003.03.03 - Upstand - Counter Flashing - Adhered on Concrete Wall

Sika General Detail. Template for translation.

900_020910_910030303C_1903_en
March 2019

Sika Services AG

Tüffenwies 16
8048 Zürich
Switzerland

Tel: +41 584364040

www.sika.com

BUILDING TRUST



DRAWING MUST ALWAYS BE REVIEWED BY A DESIGN SPECIALIST AND IF NECESSARY MODIFIED TO ENSURE SUITABILITY FOR THE SPECIFIC APPLICATION

The information contained herein and any other advice are given in good faith based on Sika's current knowledge and experience of the products when properly stored, handled and applied under normal conditions in accordance with Sika's recommendations. The information only applies to the application(s) and product(s) expressly referred to herein and is based on laboratory tests which do not replace practical tests. In case of changes in the parameters of the application, such as changes in substrates etc., or in case of a different application, consult Sika's Technical Service prior to using Sika products. The information contained herein does not relieve the user of the products from testing them for the intended application and purpose. All orders are accepted subject to our current terms of sale and delivery. Users must always refer to the most recent issue of the local Product Data Sheet for the product concerned, copies of which will be supplied on request.

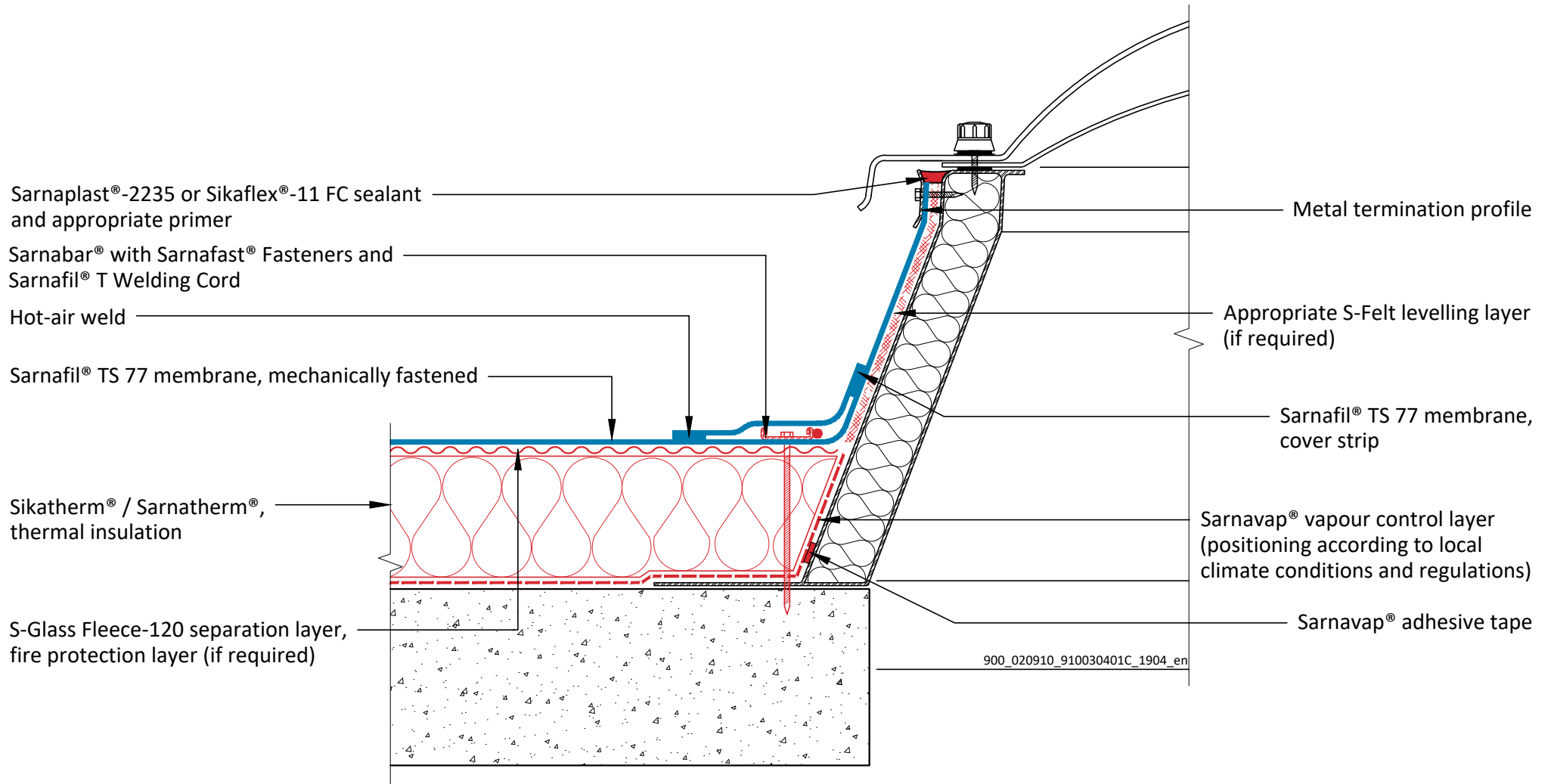

**SARNAFIL® TPO - MECHANICALLY FASTENED ROOF SYSTEM
ON CONCRETE DECK WITH THERMAL INSULATION**

SF TPO - 003.04.01 - Skylight - Sealed - Mechanically Fastened on Skylight System

Sika General Detail. Template for translation.

900_020910_910030401C_1904_en
April 2019

Sika Services AG

Tüffenwies 16
8048 Zürich
Switzerland

Tel: +41 584364040

www.sika.com

BUILDING TRUST



DRAWING MUST ALWAYS BE REVIEWED BY A DESIGN SPECIALIST AND IF NECESSARY MODIFIED TO ENSURE SUITABILITY FOR THE SPECIFIC APPLICATION

The information contained herein and any other advice are given in good faith based on Sika's current knowledge and experience of the products when properly stored, handled and applied under normal conditions in accordance with Sika's recommendations. The information only applies to the application(s) and product(s) expressly referred to herein and is based on laboratory tests which do not replace practical tests. In case of changes in the parameters of the application, such as changes in substrates etc., or in case of a different application, consult Sika's Technical Service prior to using Sika products. The information contained herein does not relieve the user of the products from testing them for the intended application and purpose. All orders are accepted subject to our current terms of sale and delivery. Users must always refer to the most recent issue of the local Product Data Sheet for the product concerned, copies of which will be supplied on request.

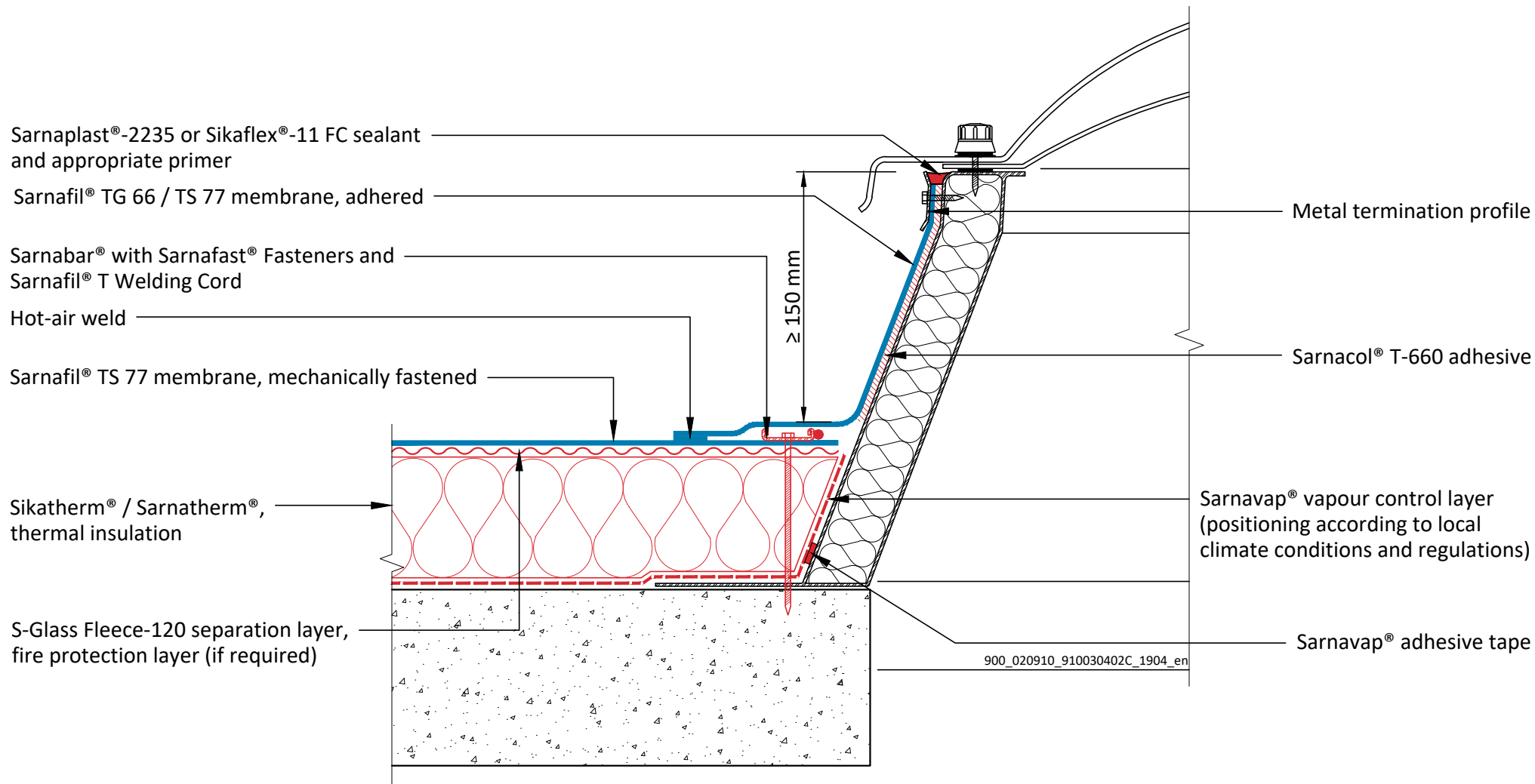

SARNAFIL® TPO - MECHANICALLY FASTENED ROOF SYSTEM ON CONCRETE DECK WITH THERMAL INSULATION

SF TPO - 003.04.02 - Skylight - Sealed - Adhered on Skylight System

Sika General Detail. Template for translation.

900_020910_910030402C_1904_en
April 2019

Sika Services AG

Tüffenwies 16
8048 Zürich
Switzerland

Tel: +41 584364040

www.sika.com

BUILDING TRUST



DRAWING MUST ALWAYS BE REVIEWED BY A DESIGN SPECIALIST AND IF NECESSARY MODIFIED TO ENSURE SUITABILITY FOR THE SPECIFIC APPLICATION

The information contained herein and any other advice are given in good faith based on Sika's current knowledge and experience of the products when properly stored, handled and applied under normal conditions in accordance with Sika's recommendations. The information only applies to the application(s) and product(s) expressly referred to herein and is based on laboratory tests which do not replace practical tests. In case of changes in the parameters of the application, such as changes in substrates etc., or in case of a different application, consult Sika's Technical Service prior to using Sika products. The information contained herein does not relieve the user of the products from testing them for the intended application and purpose. All orders are accepted subject to our current terms of sale and delivery. Users must always refer to the most recent issue of the local Product Data Sheet for the product concerned, copies of which will be supplied on request.

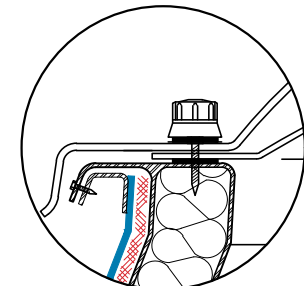
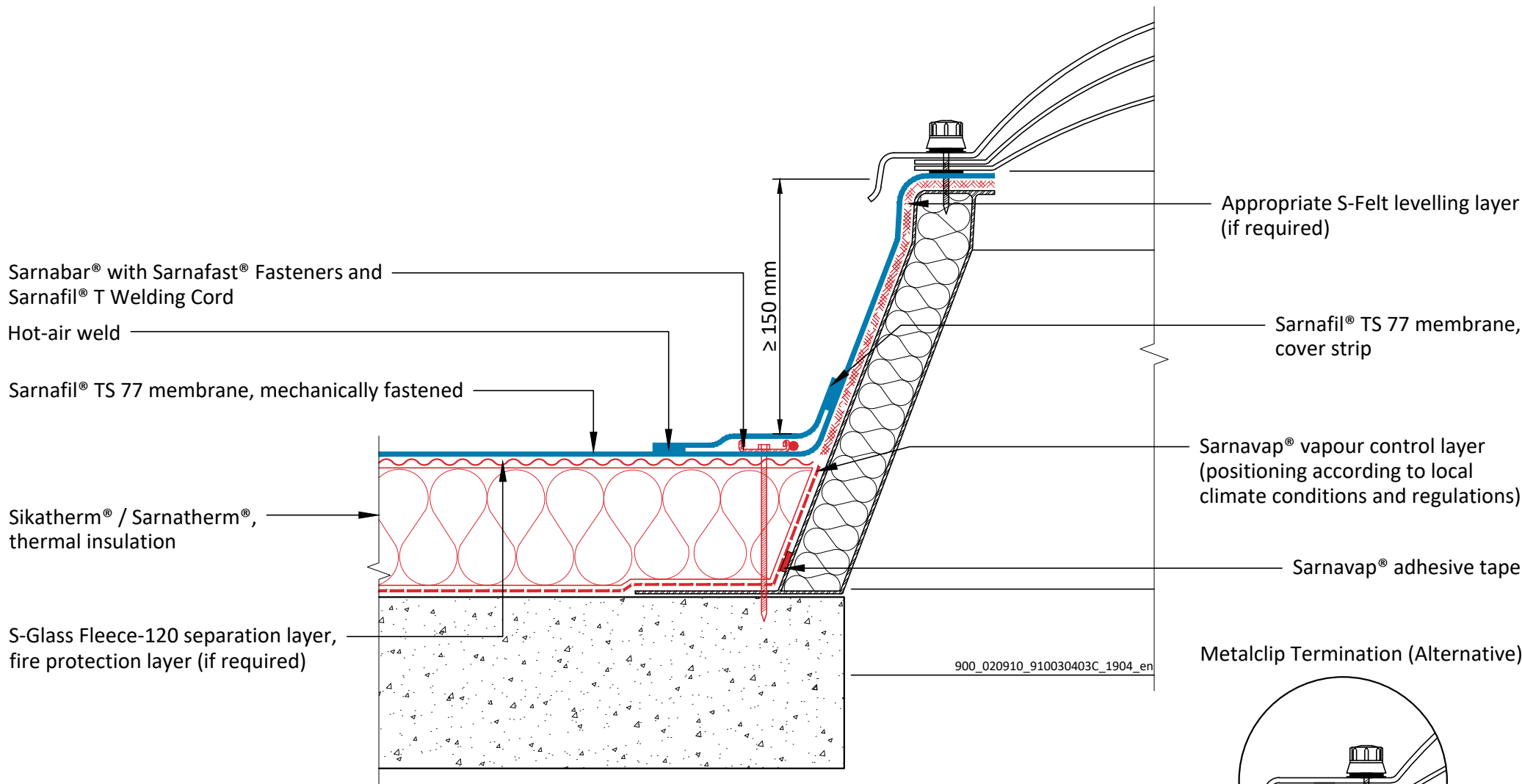

900_020910_910030403C_1904_en

**SARNAFIL® TPO - MECHANICALLY FASTENED ROOF SYSTEM
ON CONCRETE DECK WITH THERMAL INSULATION**
SF TPO - 003.04.03 - Skylight - Clamped - Mechanically Fastened on Skylight System
Sika General Detail. Template for translation.

900_020910_910030403C_1904_en
April 2019

Sika Services AG
Tüffenwies 16
8048 Zürich
Switzerland
Tel: +41 584364040
www.sika.com



DRAWING MUST ALWAYS BE REVIEWED BY A DESIGN SPECIALIST AND IF NECESSARY MODIFIED TO ENSURE SUITABILITY FOR THE SPECIFIC APPLICATION
The information contained herein and any other advice are given in good faith based on Sika's current knowledge and experience of the products when properly stored, handled and applied under normal conditions in accordance with Sika's recommendations. The information only applies to the application(s) and product(s) expressly referred to herein and is based on laboratory tests which do not replace practical tests. In case of changes in the parameters of the application, such as changes in substrates etc., or in case of a different application, consult Sika's Technical Service prior to using Sika products. The information contained herein does not relieve the user of the products from testing them for the intended application and purpose. All orders are accepted subject to our current terms of sale and delivery. Users must always refer to the most recent issue of the local Product Data Sheet for the product concerned, copies of which will be supplied on request.

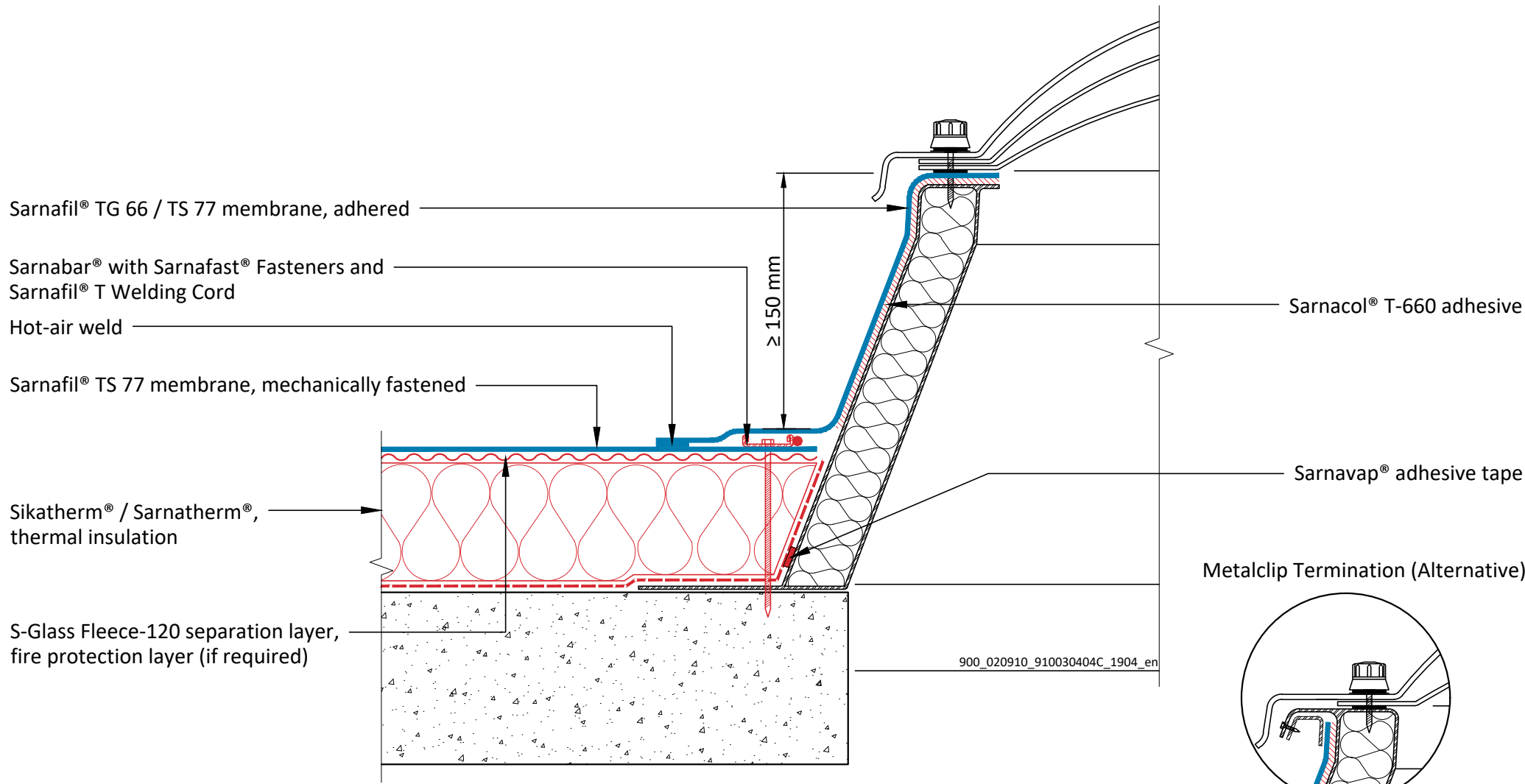

**SARNAFIL® TPO - MECHANICALLY FASTENED ROOF SYSTEM
ON CONCRETE DECK WITH THERMAL INSULATION**
SF TPO - 003.04.04 - Skylight - Clamped - Adhered on Skylight System
Sika General Detail. Template for translation.

900_020910_910030404C_1904_en
April 2019

Sika Services AG
Tüffenwies 16
8048 Zürich
Switzerland
Tel: +41 584364040
www.sika.com

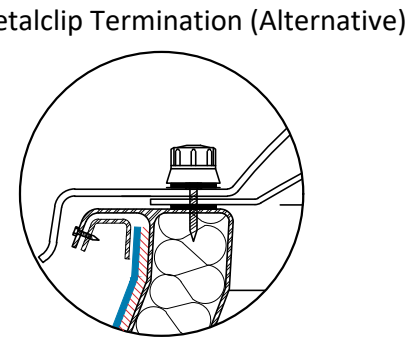

DRAWING MUST ALWAYS BE REVIEWED BY A DESIGN SPECIALIST AND IF NECESSARY MODIFIED TO ENSURE SUITABILITY FOR THE SPECIFIC APPLICATION
The information contained herein and any other advice are given in good faith based on Sika's current knowledge and experience of the products when properly stored, handled and applied under normal conditions in accordance with Sika's recommendations. The information only applies to the application(s) and product(s) expressly referred to herein and is based on laboratory tests which do not replace practical tests. In case of changes in the parameters of the application, such as changes in substrates etc., or in case of a different application, consult Sika's Technical Service prior to using Sika products. The information contained herein does not relieve the user of the products from testing them for the intended application and purpose. All orders are accepted subject to our current terms of sale and delivery. Users must always refer to the most recent issue of the local Product Data Sheet for the product concerned, copies of which will be supplied on request.



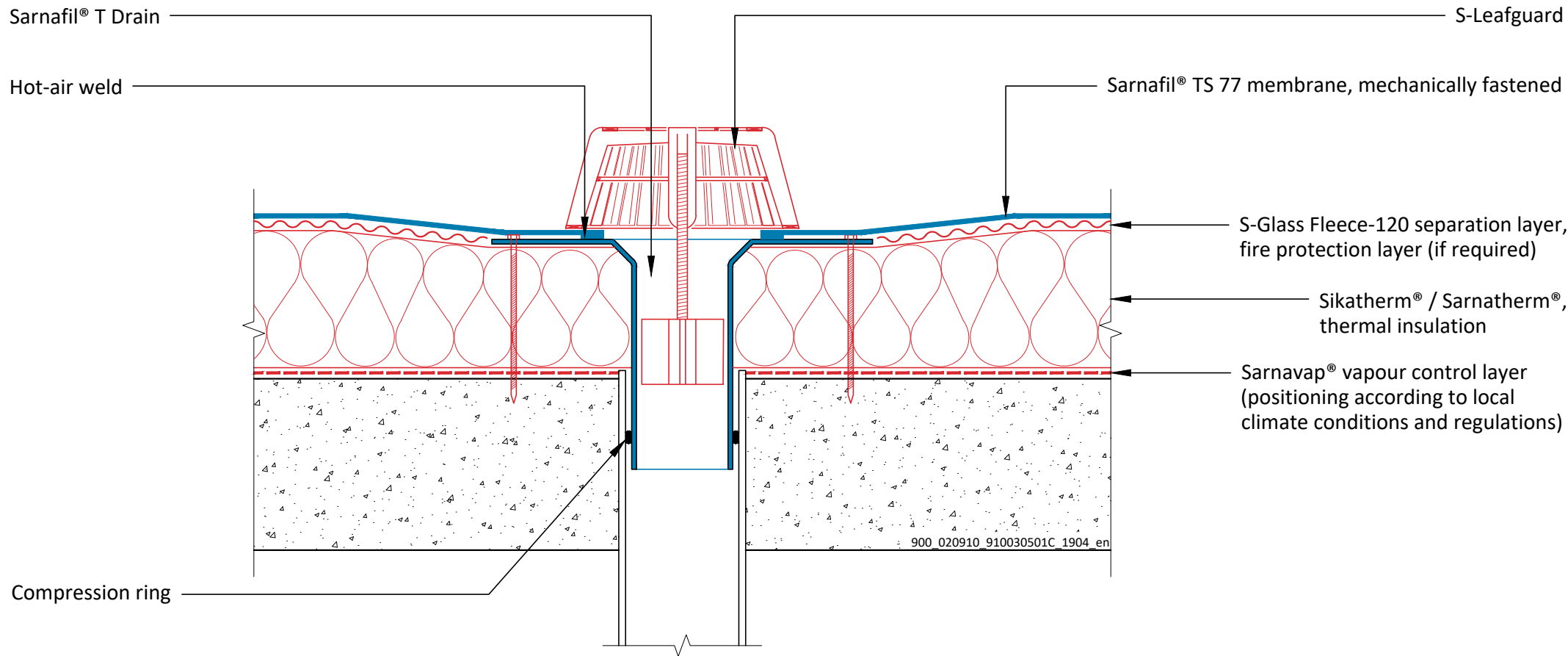

**SARNAFIL® TPO - MECHANICALLY FASTENED ROOF SYSTEM
ON CONCRETE DECK WITH THERMAL INSULATION**

SF TPO - 003.05.01 - Roof Drain (Outlet)

Sika General Detail. Template for translation.

900_020910_910030501C_1904_en

April 2019

Sika Services AG

Tüffenwies 16

8048 Zürich

Switzerland

Tel: +41 584364040

www.sika.com

BUILDING TRUST



DRAWING MUST ALWAYS BE REVIEWED BY A DESIGN SPECIALIST AND IF NECESSARY MODIFIED TO ENSURE SUITABILITY FOR THE SPECIFIC APPLICATION

The information contained herein and any other advice are given in good faith based on Sika's current knowledge and experience of the products when properly stored, handled and applied under normal conditions in accordance with Sika's recommendations. The information only applies to the application(s) and product(s) expressly referred to herein and is based on laboratory tests which do not replace practical tests. In case of changes in the parameters of the application, such as changes in substrates etc., or in case of a different application, consult Sika's Technical Service prior to using Sika products. The information contained herein does not relieve the user of the products from testing them for the intended application and purpose. All orders are accepted subject to our current terms of sale and delivery. Users must always refer to the most recent issue of the local Product Data Sheet for the product concerned, copies of which will be supplied on request.

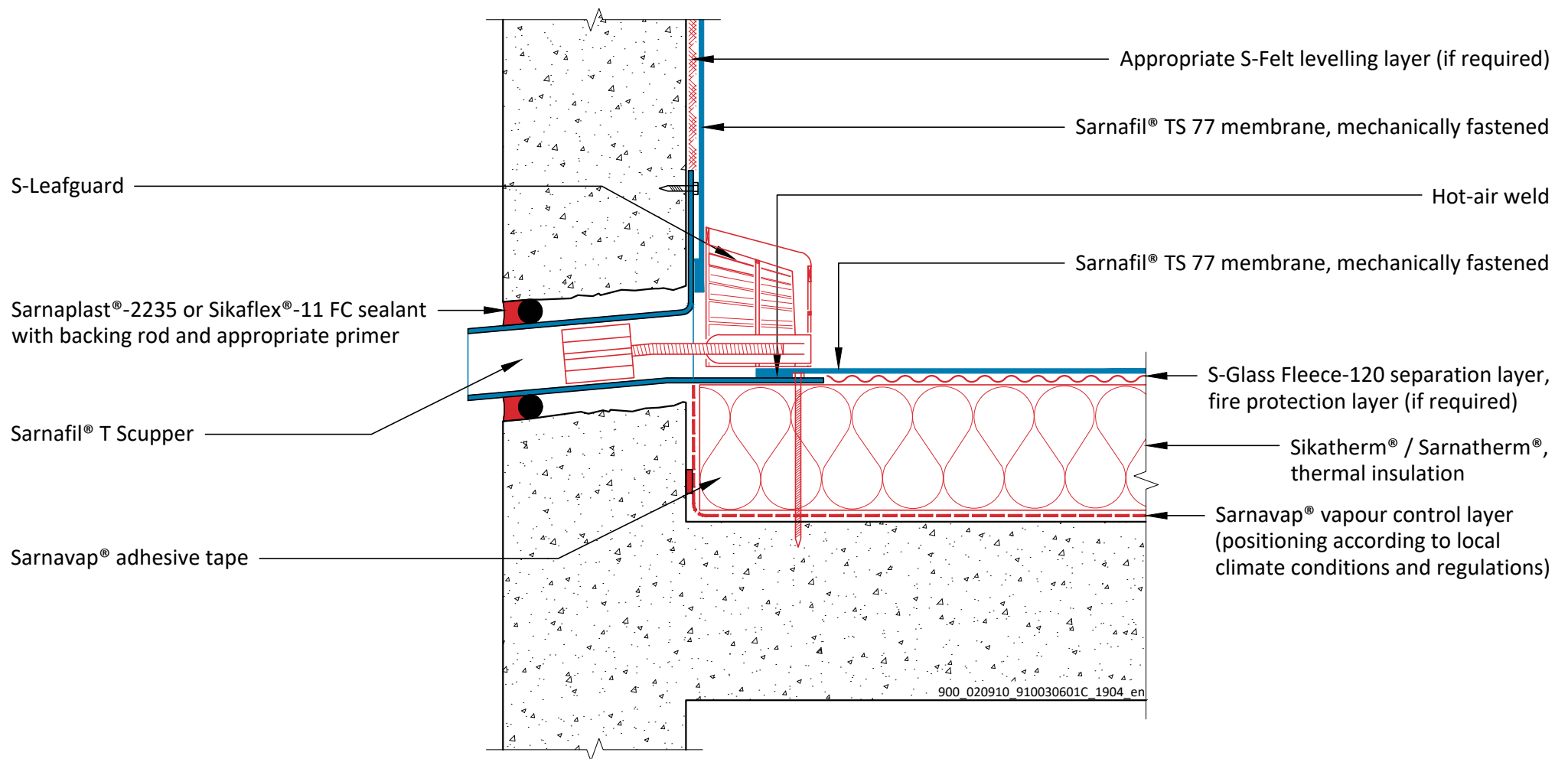

**SARNAFIL® TPO - MECHANICALLY FASTENED ROOF SYSTEM
ON CONCRETE DECK WITH THERMAL INSULATION**

SF TPO - 003.06.01 - Scupper - Mechanically Fastened on Concrete Wall

Sika General Detail. Template for translation.

900_020910_910030601C_1904_en
April 2019

Sika Services AG

Tüffenwies 16
8048 Zürich
Switzerland

Tel: +41 584364040

www.sika.com

BUILDING TRUST



DRAWING MUST ALWAYS BE REVIEWED BY A DESIGN SPECIALIST AND IF NECESSARY MODIFIED TO ENSURE SUITABILITY FOR THE SPECIFIC APPLICATION

The information contained herein and any other advice are given in good faith based on Sika's current knowledge and experience of the products when properly stored, handled and applied under normal conditions in accordance with Sika's recommendations. The information only applies to the application(s) and product(s) expressly referred to herein and is based on laboratory tests which do not replace practical tests. In case of changes in the parameters of the application, such as changes in substrates etc., or in case of a different application, consult Sika's Technical Service prior to using Sika products. The information contained herein does not relieve the user of the products from testing them for the intended application and purpose. All orders are accepted subject to our current terms of sale and delivery. Users must always refer to the most recent issue of the local Product Data Sheet for the product concerned, copies of which will be supplied on request.

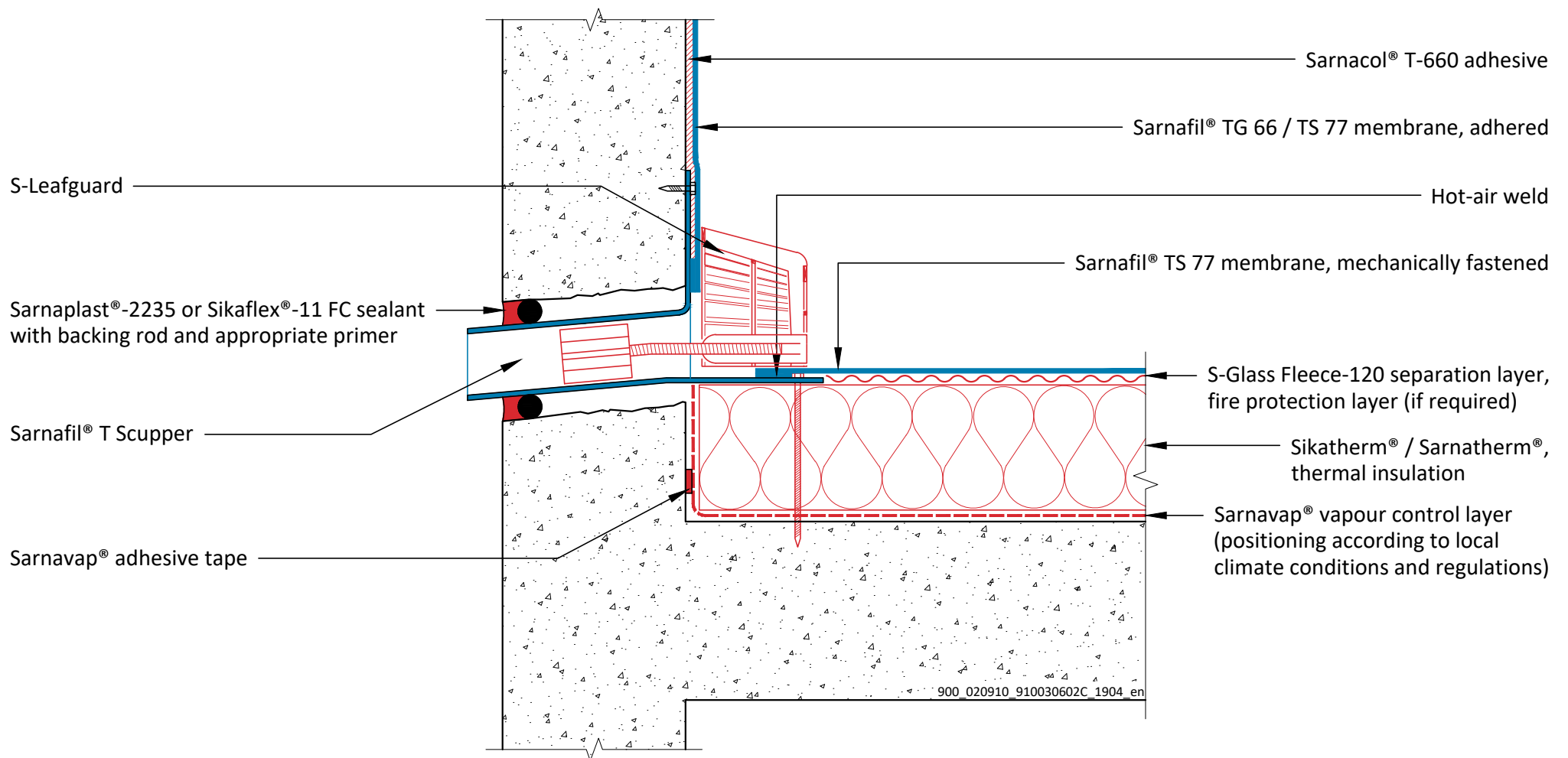

**SARNAFIL® TPO - MECHANICALLY FASTENED ROOF SYSTEM
ON CONCRETE DECK WITH THERMAL INSULATION**

SF TPO - 003.06.02 - Scupper - Adhered on Concrete Wall

Sika General Detail. Template for translation.

900_020910_910030602C_1904_en
April 2019

Sika Services AG

Tüffenwies 16
8048 Zürich
Switzerland

Tel: +41 584364040

www.sika.com

BUILDING TRUST



DRAWING MUST ALWAYS BE REVIEWED BY A DESIGN SPECIALIST AND IF NECESSARY MODIFIED TO ENSURE SUITABILITY FOR THE SPECIFIC APPLICATION

The information contained herein and any other advice are given in good faith based on Sika's current knowledge and experience of the products when properly stored, handled and applied under normal conditions in accordance with Sika's recommendations. The information only applies to the application(s) and product(s) expressly referred to herein and is based on laboratory tests which do not replace practical tests. In case of changes in the parameters of the application, such as changes in substrates etc., or in case of a different application, consult Sika's Technical Service prior to using Sika products. The information contained herein does not relieve the user of the products from testing them for the intended application and purpose. All orders are accepted subject to our current terms of sale and delivery. Users must always refer to the most recent issue of the local Product Data Sheet for the product concerned, copies of which will be supplied on request.

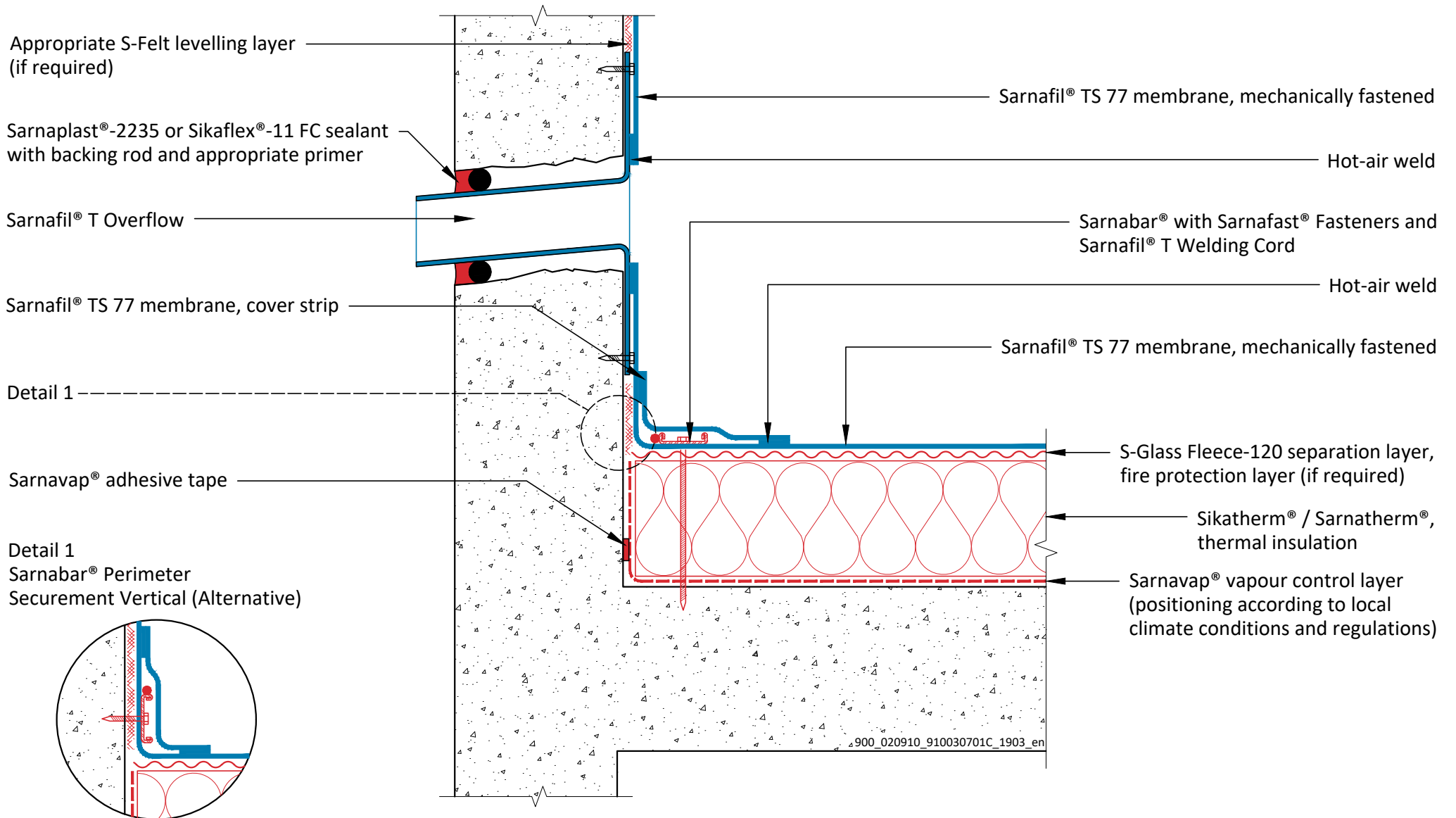

**SARNAFIL® TPO - MECHANICALLY FASTENED ROOF SYSTEM
ON CONCRETE DECK WITH THERMAL INSULATION**
SF TPO - 003.07.01 - Overflow - Mechanically Fastened on Concrete Wall
Sika General Detail. Template for translation.

900_020910_910030701C_1903_en
March 2019

Sika Services AG
Tüffenwies 16
8048 Zürich
Switzerland
Tel: +41 584364040
www.sika.com

BUILDING TRUST



DRAWING MUST ALWAYS BE REVIEWED BY A DESIGN SPECIALIST AND IF NECESSARY MODIFIED TO ENSURE SUITABILITY FOR THE SPECIFIC APPLICATION

The information contained herein and any other advice are given in good faith based on Sika's current knowledge and experience of the products when properly stored, handled and applied under normal conditions in accordance with Sika's recommendations. The information only applies to the application(s) and product(s) expressly referred to herein and is based on laboratory tests which do not replace practical tests. In case of changes in the parameters of the application, such as changes in substrates etc., or in case of a different application, consult Sika's Technical Service prior to using Sika products. The information contained herein does not relieve the user of the products from testing them for the intended application and purpose. All orders are accepted subject to our current terms of sale and delivery. Users must always refer to the most recent issue of the local Product Data Sheet for the product concerned, copies of which will be supplied on request.

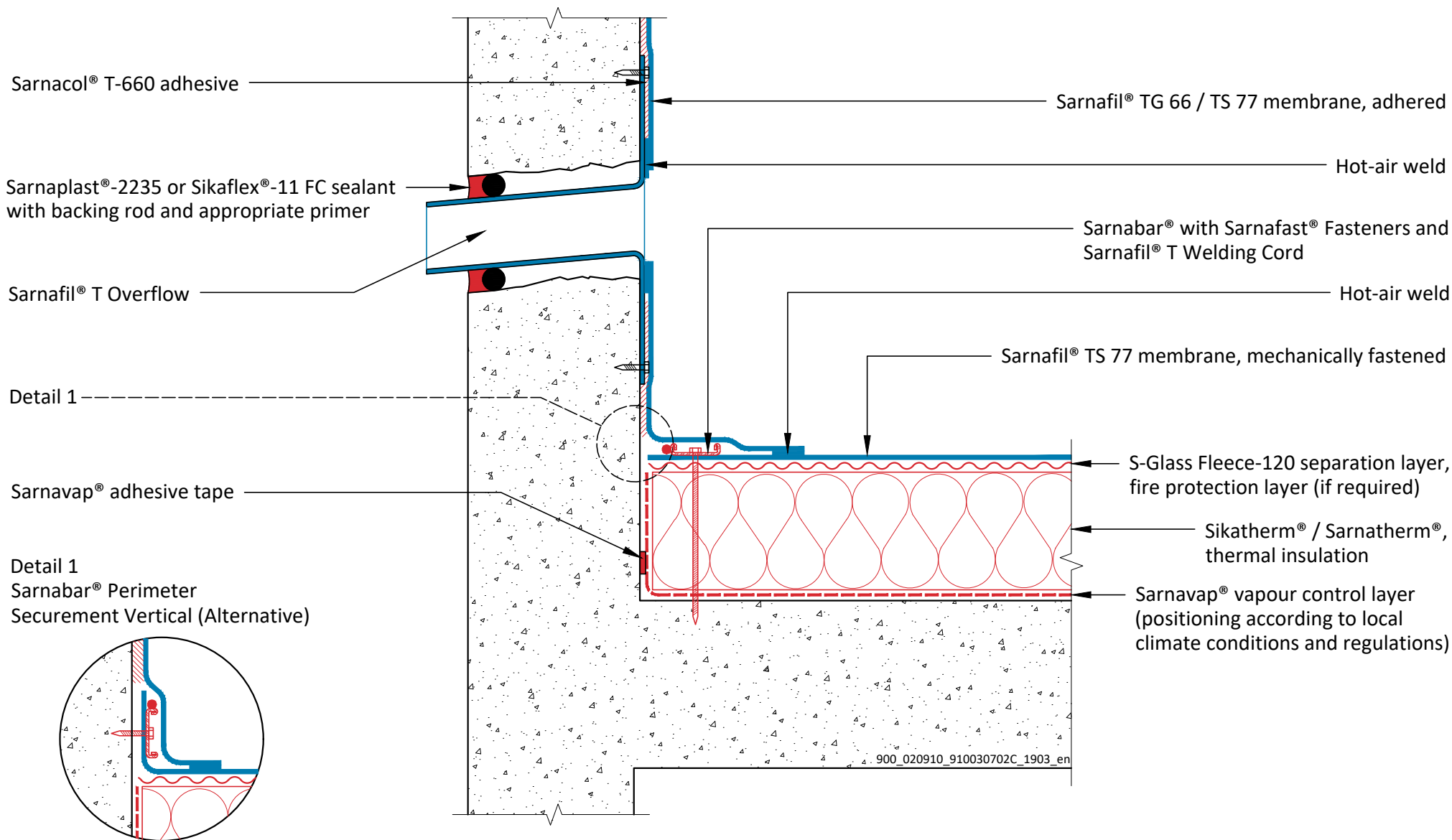

**SARNAFIL® TPO - MECHANICALLY FASTENED ROOF SYSTEM
ON CONCRETE DECK WITH THERMAL INSULATION**

SF TPO - 003.07.02 - Overflow - Adhered on Concrete Wall

Sika General Detail. Template for translation.

DRAWING MUST ALWAYS BE REVIEWED BY A DESIGN SPECIALIST AND IF NECESSARY MODIFIED TO ENSURE SUITABILITY FOR THE SPECIFIC APPLICATION

The information contained herein and any other advice are given in good faith based on Sika's current knowledge and experience of the products when properly stored, handled and applied under normal conditions in accordance with Sika's recommendations. The information only applies to the application(s) and product(s) expressly referred to herein and is based on laboratory tests which do not replace practical tests. In case of changes in the parameters of the application, such as changes in substrates etc., or in case of a different application, consult Sika's Technical Service prior to using Sika products. The information contained herein does not relieve the user of the products from testing them for the intended application and purpose. All orders are accepted subject to our current terms of sale and delivery. Users must always refer to the most recent issue of the local Product Data Sheet for the product concerned, copies of which will be supplied on request.

900_020910_910030702C_1903_en
March 2019

Sika Services AG

Tüffenwies 16
8048 Zürich
Switzerland

Tel: +41 584364040

www.sika.com

BUILDING TRUST



Sarnaplast®-2235 or Sikaflex®-11 FC sealant and appropriate primer

Hot-air weld

Sarnafil® TS 77 membrane, mechanically fastened

Point fastening of vent pipe / post flashing

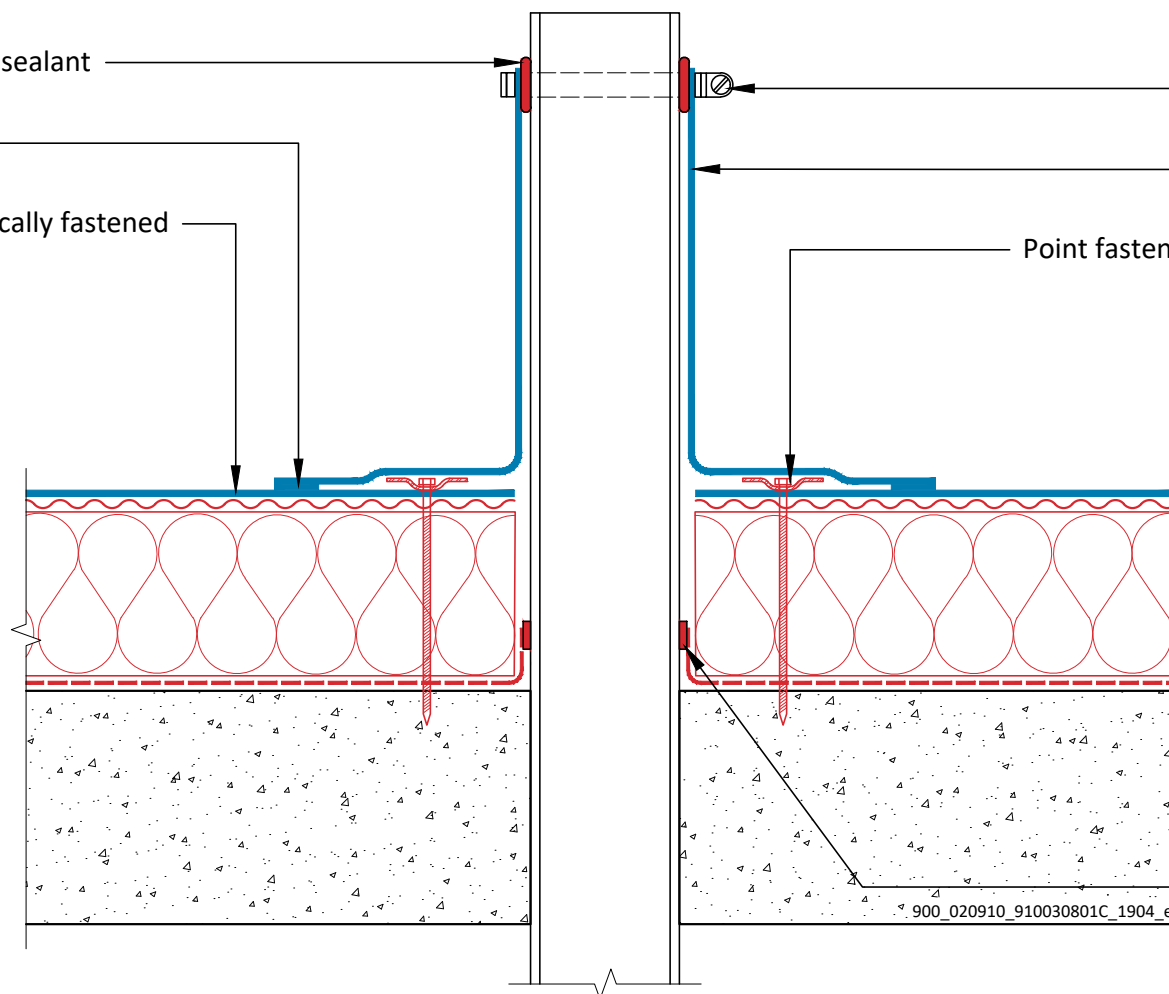
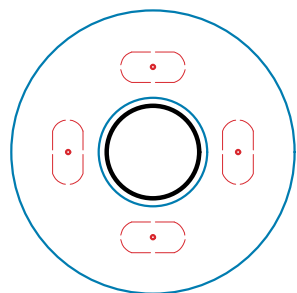

Stainless steel jubilee clip / shrinking hose

Sarnafil® T Pipe / Post Flashing

Point fastening with Sarnafast® Washers and Fasteners

S-Glass Fleece-120 separation layer, fire protection layer (if required)

Sikatherm® / Sarnatherm®, thermal insulation

Sarnavap® vapour control layer (positioning according to local climate conditions and regulations)

Sarnavap® adhesive tape

900_020910_910030801C_1904_en

SARNAFIL® TPO - MECHANICALLY FASTENED ROOF SYSTEM ON CONCRETE DECK WITH THERMAL INSULATION

SF TPO - 003.08.01 - Vent Pipe / Post

Sika General Detail. Template for translation.

900_020910_910030801C_1904_en
April 2019

Sika Services AG

Tüffenwies 16
8048 Zürich
Switzerland

Tel: +41 584364040

www.sika.com

BUILDING TRUST



DRAWING MUST ALWAYS BE REVIEWED BY A DESIGN SPECIALIST AND IF NECESSARY MODIFIED TO ENSURE SUITABILITY FOR THE SPECIFIC APPLICATION
The information contained herein and any other advice are given in good faith based on Sika's current knowledge and experience of the products when properly stored, handled and applied under normal conditions in accordance with Sika's recommendations. The information only applies to the application(s) and product(s) expressly referred to herein and is based on laboratory tests which do not replace practical tests. In case of changes in the parameters of the application, such as changes in substrates etc., or in case of a different application, consult Sika's Technical Service prior to using Sika products. The information contained herein does not relieve the user of the products from testing them for the intended application and purpose. All orders are accepted subject to our current terms of sale and delivery. Users must always refer to the most recent issue of the local Product Data Sheet for the product concerned, copies of which will be supplied on request.

Sarnafil® TS 77 membrane, mechanically fastened

S-Glass Fleece-120 separation layer,
fire protection layer (if required)

Sikatherm® / Sarnatherm®,
thermal insulation

Sarnavap® vapour control layer
(positioning according to local
climate conditions and regulations)

Sarnafil® TS 77 membrane, mechanically fastened

Hot-air weld

Spot fastening with Sarnafast®
Washers and Fasteners

Metal flashing

Sarnafil® TS 77 membrane, cover strip

Sarnabar® with Sarnafast® Fasteners

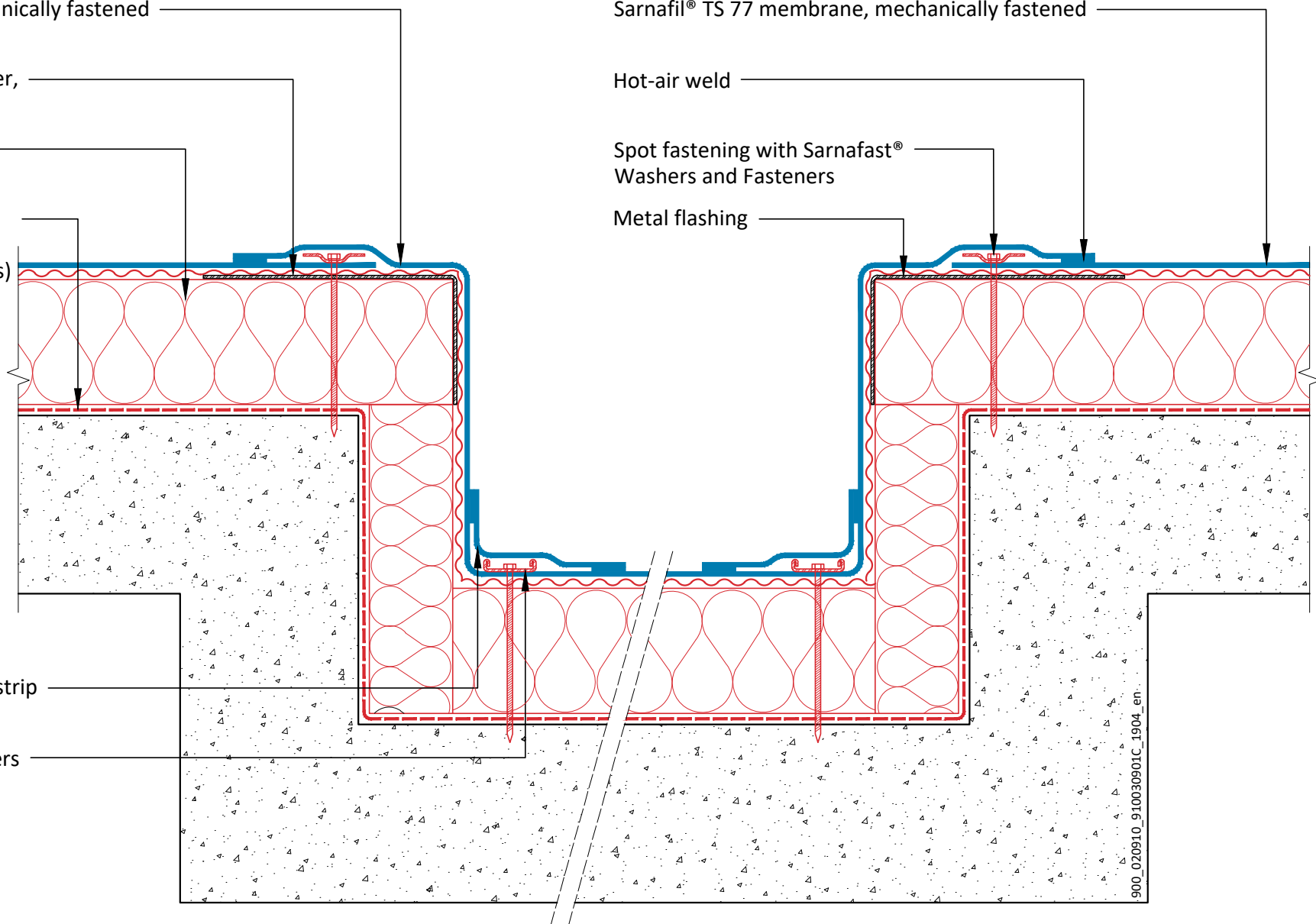

900_020910_910030901C_1904_en

**SARNAFIL® TPO - MECHANICALLY FASTENED ROOF SYSTEM
ON CONCRETE DECK WITH THERMAL INSULATION**

SF TPO - 003.09.01 - Gutter

Sika General Detail. Template for translation.

900_020910_910030901C_1904_en
April 2019

Sika Services AG

Tüffenwies 16
8048 Zürich
Switzerland

Tel: +41 584364040

www.sika.com

BUILDING TRUST



DRAWING MUST ALWAYS BE REVIEWED BY A DESIGN SPECIALIST AND IF NECESSARY MODIFIED TO ENSURE SUITABILITY FOR THE SPECIFIC APPLICATION

The information contained herein and any other advice are given in good faith based on Sika's current knowledge and experience of the products when properly stored, handled and applied under normal conditions in accordance with Sika's recommendations. The information only applies to the application(s) and product(s) expressly referred to herein and is based on laboratory tests which do not replace practical tests. In case of changes in the parameters of the application, such as changes in substrates etc., or in case of a different application, consult Sika's Technical Service prior to using Sika products. The information contained herein does not relieve the user of the products from testing them for the intended application and purpose. All orders are accepted subject to our current terms of sale and delivery. Users must always refer to the most recent issue of the local Product Data Sheet for the product concerned, copies of which will be supplied on request.

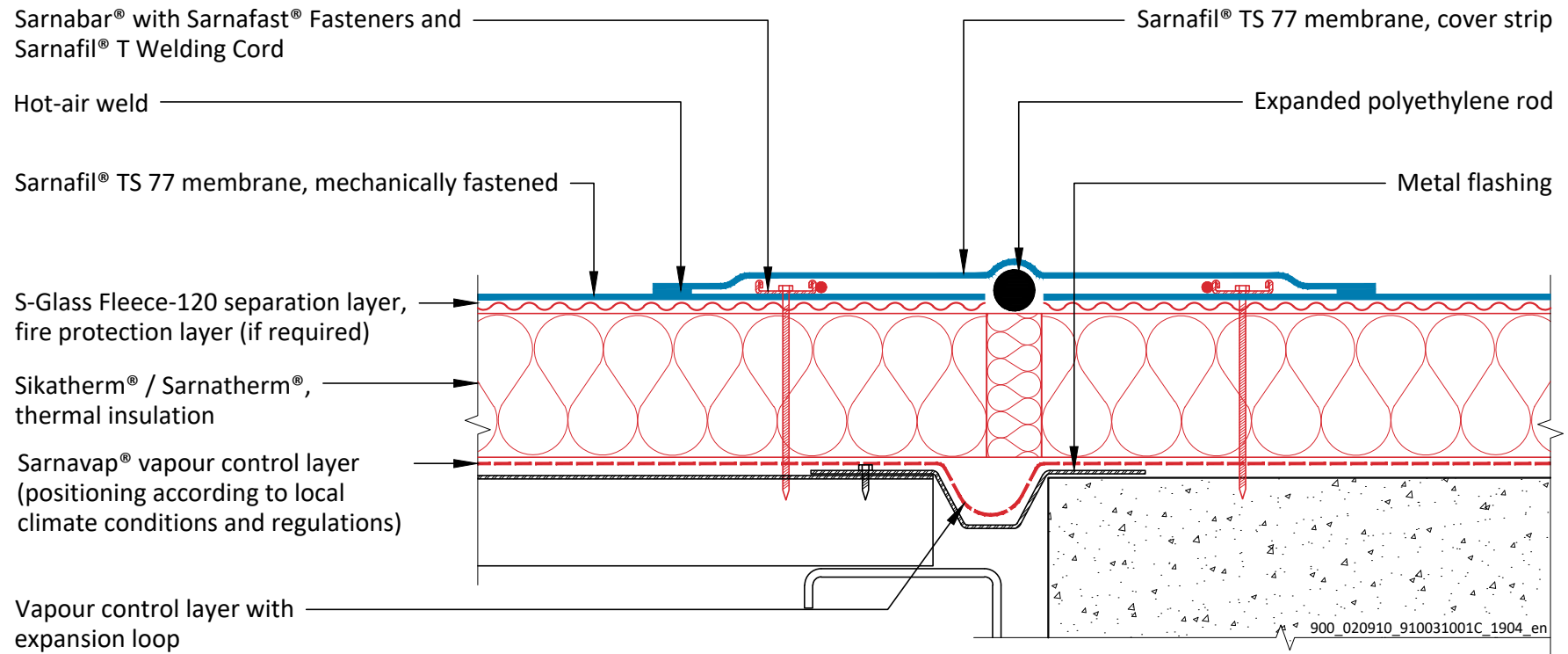

**SARNAFIL® TPO - MECHANICALLY FASTENED ROOF SYSTEM
ON CONCRETE DECK WITH THERMAL INSULATION**

SF TPO - 003.10.01 - Movement Joint

Sika General Detail. Template for translation.

900_020910_910031001C_1904_en

April 2019

Sika Services AG

Tüffenwies 16

8048 Zürich

Switzerland

Tel: +41 584364040

www.sika.com

BUILDING TRUST



DRAWING MUST ALWAYS BE REVIEWED BY A DESIGN SPECIALIST AND IF NECESSARY MODIFIED TO ENSURE SUITABILITY FOR THE SPECIFIC APPLICATION

The information contained herein and any other advice are given in good faith based on Sika's current knowledge and experience of the products when properly stored, handled and applied under normal conditions in accordance with Sika's recommendations. The information only applies to the application(s) and product(s) expressly referred to herein and is based on laboratory tests which do not replace practical tests. In case of changes in the parameters of the application, such as changes in substrates etc., or in case of a different application, consult Sika's Technical Service prior to using Sika products. The information contained herein does not relieve the user of the products from testing them for the intended application and purpose. All orders are accepted subject to our current terms of sale and delivery. Users must always refer to the most recent issue of the local Product Data Sheet for the product concerned, copies of which will be supplied on request.