



# Roofing Sika SolaRoof®

CONCEPT FOR DURABLE INSTALLATION OF  
PV MODULES ON FLAT ROOFS

# CONTENT

**03** Sika SolaRoof®

---

**04** Sika® SolarMount-1 (SSM1)

---

**06** Testing and Approvals

---

**07** SSM1 Design

---

**08** SSM1 Installation

---

**09** PV Concepts & Business Models

---

**10** Global Experience

---

**11** Project Management & Benefits

---



Worry-free solar solutions  
thanks to cooperation between  
Sika® and Centroplan

Founded in 2007, Centroplan specializes in medium to large-scale photovoltaic solar power systems for both rooftop and ground-mounted installations. An experienced team of engineers, business economists and project managers based in several countries handles all phases of the photovoltaic project (project concept and development, project financing, design & engineering, procurement & installation, operation & maintenance).

By coordinating the project partners and suppliers, Centroplan provides the highest-quality photovoltaic system from a single source.



# Sika SolaRoof®

SIMPLY STRONG

The Sika SolaRoof® system is a lightweight, non-penetrating, integrated solar solution for thermoplastic roofs that outperforms conventional mounting systems. It combines the proven performance of a Sika roofing system with Sika® SolarMount-1 (SSM1) – an innovative, engineered solution for long-term securement of rooftop photovoltaic modules.

## Rooftop PV – the perfect use of empty roof space

Rooftop solar installations are becoming increasingly popular worldwide. An empty flat roof is a wasted space resource and most are not shaded. That's why more and more building owners are realizing the opportunity to make effective use of their roof space and to improve their environmental footprint through sustainable electricity production. Such installations are sound investments, designed to provide a return over the long-term. In addition, they reduce dependency on utility providers thanks to on-site power generation for in-house consumption.

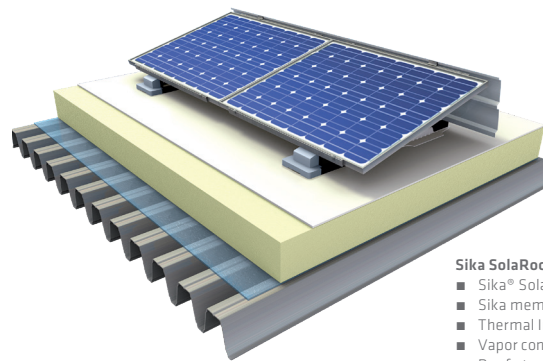

**Sika SolaRoof® build-up:**

- Sika® SolarMount-1
- Sika membrane
- Thermal Insulation
- Vapor control layer
- Roof structure (e.g. metal deck, concrete)

The roofing system, with a service life expectancy of 20+ years, is a critical component of the installed PV plant. The correct roof build-up is key when it comes to durability. Sika has 50+ years of experience in the manufacture of single-ply membranes that not only meet the demands for performance and life expectancy as stand-alone waterproofing systems but also form an ideal substrate for the Sika® SolarMount-1 system.

## Architectural and structural requirements:

Building height	■ Max. 20 meters. Higher roofs must be individually assessed.
Roof slope	■ Up to 5° (1:12 or 8 %) as standard ■ Up to 10° with additional measures <sup>1)</sup>
Roof loadbearing capacity	■ Sufficient for SSM1 loads. This can be determined by a structural engineer once the PV system has been planned.
Sika roofing membrane	■ New membrane provides optimal roof warranty coverage. → The life expectancy of the Sika roof build-up and the PV system match perfectly ■ FPO and PVC membrane, min. thickness 1.5 mm (2.0 mm for max. warranty coverage)

## Requirements for the roof build-up<sup>1)</sup>:

Membrane fastening	■ Mechanically fastened ■ Fully adhered <sup>2)</sup>
Thermal insulation	■ PIR, EPS, XPS board (depending on local availability and temperature conditions) ■ Mineral fiber board with compressive strength $\geq 70$ kPa at 10 % deformation (as per EN 826) ■ Roof cover boards as an option for optimum load distribution
Vapor control layer	■ According to specific building physics requirements
Roof structure	■ Metal deck (trapezoidal), concrete, wood (PIR metal sandwich panels and standing seam metal roofs are not suitable for Sika SolaRoof®) ■ The life expectancy of an existing roof structure with a new Sika build-up (reroofing) should be at least as long as that of the PV system.

<sup>1)</sup>depends on local product range, standards and approvals

**Please consult Sika or Centroplan to assess whether your specific roof is suitable for installation of a Sika SolaRoof®.**

# Sika® SolarMount-1 (SSM1)

## VERSATILE MOUNTING SYSTEM FOR USE WITH SIKA ROOFING MEMBRANES

**Sika® SolarMount-1** is the aerodynamic mounting system for **Sika SolaRoof®**. It is used for the installation of rigid photovoltaic (PV) modules on flat or low-slope roofs. SSM1 can easily be installed on mechanically fastened or fully adhered Sika single-ply TPO and PVC membranes, depending on the local product range, standards and approvals.

### SSM1 system components

- Injection-molded **SSM1 mount** (recycled PP) with an angle of inclination of 15° (angle is not adjustable). Fixed mounting rails hold the PV modules in place.
- The **Sika® SolarClick welding flange** is injection molded from compounds compatible with the roofing membrane and is hot-air welded to the membrane to provide permanent and secure attachment. The flanges are mechanically fastened to the mount and transfer horizontal wind loads to the roof structure.



Sika® SolarClick

- **Accessories:** wind deflectors (for south orientation), module mounting rails, screws, and clamps.



SSM1 mount with 2 Sika® SolarClick flanges

### SSM1 key features

- Module inclination angle: ■ 15° to the roof plane
- PV module orientation: ■ PV modules on SSM1 mounts can be installed with either south or east-west orientation. The same components are used for both variants.
- PV module types: ■ Framed crystalline PV panels
- Average weight: ■ ca. 10-18 kg/m<sup>2</sup> (including PV modules, depending on south or east-west orientation)  
■ Green roof system < 40 kg/m<sup>2</sup> (including PV modules; vegetation mat saturated)
- Load transfer: ■ Slip sheets, separation layers, or friction enhancers are not required. Fixation of the SSM1 system requires no penetration of the roof build-up.

### SSM1 on lightweight green roofs

Sika® SolarMount-1 can also be used in combination with a lightweight green roof system. The advantages include low roof loads and lower maintenance than roofs with a "standard" green roof substrate. The system provides a water runoff coefficient of < 0.5 according to the Institute for Landscape Architecture, Leibniz University Hannover, Germany.



## South orientation

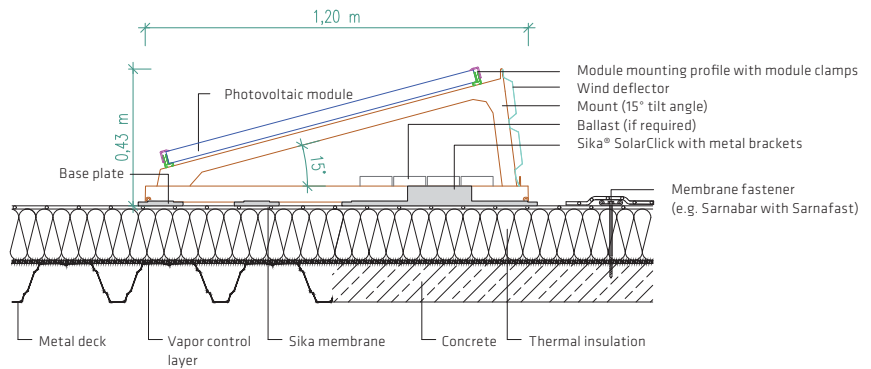

## East-West orientation

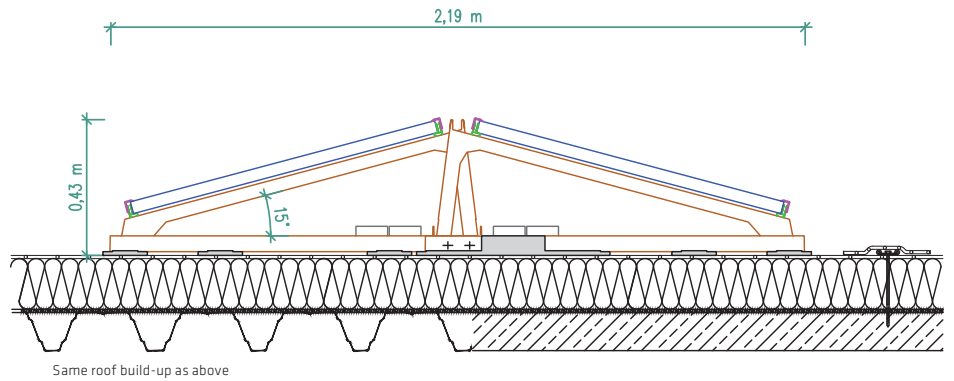

## Lightweight green roofs

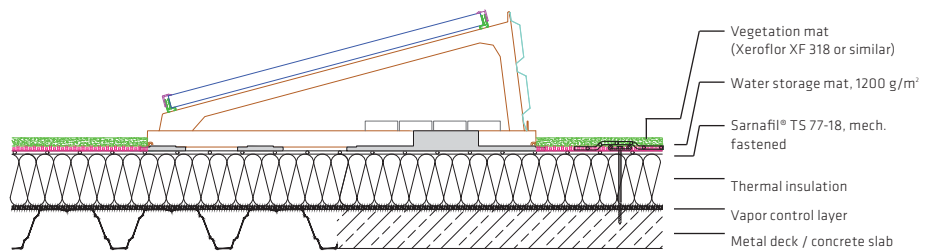

**Lightweight green roof build-up\*:** The green roof build-up is installed between the PV module rows only. The roof surface beneath the PV modules remains uncovered in order to avoid uncontrolled plant growth and the associated high maintenance costs.

\* Local regulations for green roofs and fire protection must be observed

# TESTING AND APPROVALS

## COMPREHENSIVE LABORATORY EVALUATION OF ALL LOADING CONDITIONS

Thorough full-system testing of SSM1 on single-ply membrane roofs has been conducted in several international labs since 2012. The results confirm superior performance in south and east-west configurations – even under extreme conditions. Certificates and approvals are available.

Mechanical testing of all components and connections on original Sika roof build-ups (roof structure, thermal insulation, membrane including fastening system) has been conducted at different temperatures in close coordination with various regulating bodies and construction institutes:

- Static testing
- Dynamic testing (load cycles at increasing load levels up to failure)
- Temperatures: -20 °C, +23 °C, +80 °C
- Fire testing as per UL 2703, Section 15, Fire Performance

The following loading conditions were tested:

- Horizontal loading (parallel to the frame axis)
- Lateral loading (perpendicular to the frame axis)
- Load distribution tests of multiple SSM1 frames

All test series showed sufficient factors of safety for the SSM1 system as well as for the membrane and its fastening system performing under the following loading and conditions:

- Wind loads
- Seismic loads
- Low and high temperatures
- Material aging throughout the product service life
- Broad general environmental exposure

**Stable positioning of SSM1 does not rely on friction between the membrane and the mounting structure.** SSM1 will not shift its position on the roof due to changing material characteristics as a result of weathering and aging or due to material expansion and contraction.

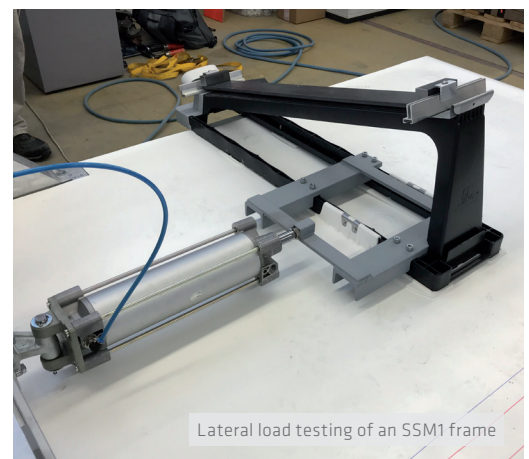
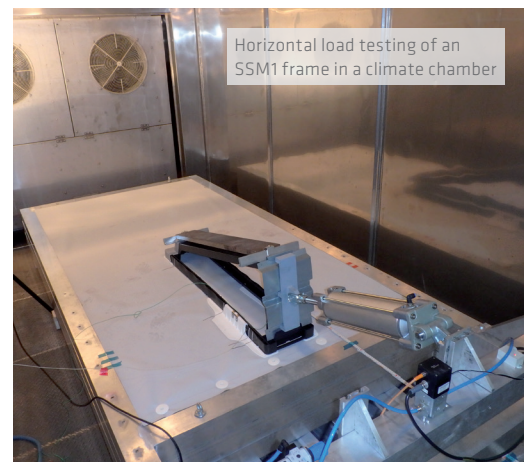

### Examples of various certificates and approvals:

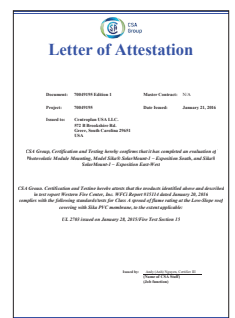
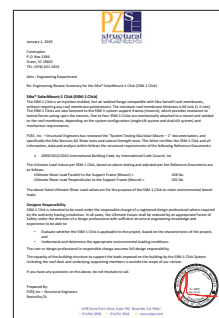
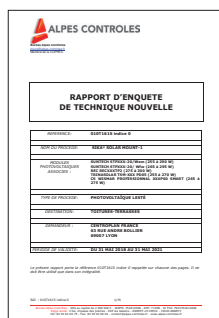

# SSM1 DESIGN

## THOROUGH EVALUATION OF SITE-SPECIFIC FACTORS

The engineering phase is one of the most crucial steps of the project. Special focus is placed on site-specific conditions and influences such as wind and snow loads, roof build-up, solar exposure, objects above the roof (e.g. chimneys, trees), and energy yield. The engineered solution must take all these factors into account as well as meet the client's expectations regarding budget, return on investment, and intended on-site energy consumption or storage, etc.

The design and structural calculations for the SSM1 system are handled by the specialized PV solution provider Centroplan GmbH, a competence center for efficient and economical rooftop and solar solutions, with subsidiaries in the USA, China, and other countries. Their experienced engineers use custom software for SSM1 design.



The SSM1 design concept is as follows:

- Horizontal wind loads (parallel to the roof) are transferred via Sika® SolarClick fasteners to the membrane and the roof structure. No slip sheets or ballast is required.
- Vertical wind loads (uplift) are countered by the dead weight of the SSM1 elements and the PV modules. This makes the SSM1 system ideal for lightweight roofs. In rare cases of extreme uplift, ballast units can be placed in the recess of the mounts.

Boundary-layer wind-tunnel testing in specialized labs is conducted in order to determine the actual loads that the SSM1 installation will be exposed to. The custom software is used calculate the required number of SolarClick elements and the spacing of the mounts for each sub-array. The output includes a project-specific PV module layout, a ballast plan, and construction documents.

In south-oriented configurations, the typical row spacing is 1.5 to 2.5 m. The proposed aisle width for east-west installations is roughly 0.5 m in order to allow easy access for maintenance. Roof perimeter setback is typically 1.0 - 1.5 meters.

In any case, an SSM1 installation adds a moderate additional roof load of 10-18 kg/m<sup>2</sup>. The roof structure must be strong enough to carry this additional load.

Wind-load calculations for the roof build-up are prepared by the local Sika company. Gravel-ballasted membranes must be fastened as well as exposed roofs in order to resist horizontal wind loads.

Sika conducts a monitoring program for the most exposed SSM1 installations. Periodic examinations are conducted in order to check for material changes of components or other irregularities of membranes and fasteners.

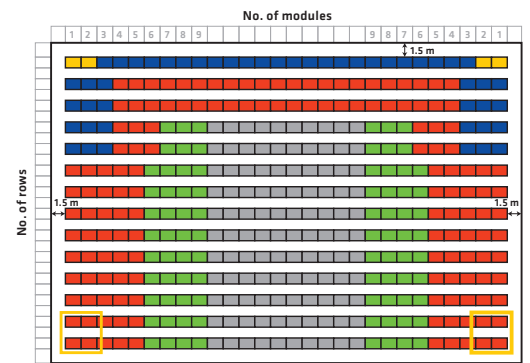
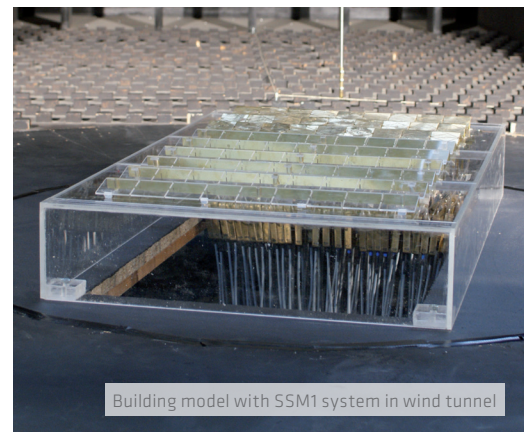

Various wind-load zones of a general SSM1 installation

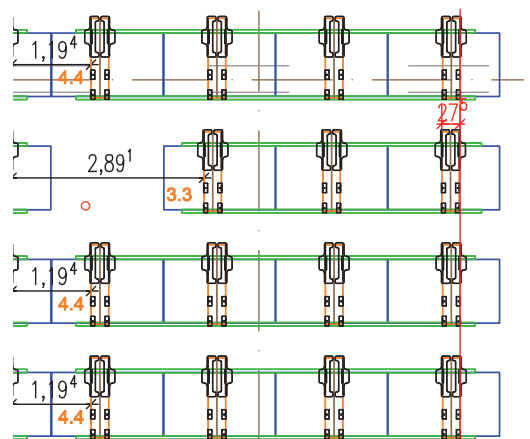

Computer-generated roof-specific PV module installation plan



# SSM1 INSTALLATION

QUICK AND EASY WITH NO ROOF PENETRATIONS;  
PERMANENT STABLE POSITIONING

A unique feature of Sika® SolarMount-1 is that the installation cannot move on the roof surface over the long term. The Sika SolarClick fasteners are attached to the roofing membrane by hot-air welding and transfer the loads to the roof structure. Strong emphasis is placed on the training of contractors authorized to weld Sika roofing components.

## SSM1 PV module orientation and variants

A big advantage of the Sika® SolarMount-1 system is the modular design, which makes it easy to accommodate specific conditions on the roof. SSM1 variants from 1 to 4 PV modules mounted on 2 to 7 mounts are so-called “standard” south-oriented configurations (e.g. Sika® SolarMount-1 3.4: 3 modules on 4 supports).

## SSM1 components delivery to site

All Sika® SolarMount-1 components are delivered exclusively and directly to the job site from the Centroplan distribution center. They are packed on pallets and in box pallets for simplified logistics. These pallets are placed on the roof, which must be capable of carrying the concentrated loads. SSM1 components may be delivered only to projects that have been calculated and designed by Centroplan and for which layout and ballast plans are available.

## Roof and Material Preparation

It must be ensured that the roof surface is clean before the SSM1 system is installed.

For larger installations it is recommended to preassemble the SSM1 mounts on assembly tables. This speeds the installation and allows working at a more comfortable height.

## SSM1 Installation

In order to achieve the greatest flexibility in installation, the roofing contractor that installed the roof build-up can also install the Sika® SolarMount-1 system, after having completed the corresponding training program.

Installation of the SSM1 system requires only a limited number of components to be assembled on site. This allows fast and easy setup of the PV plant. Installation manuals with step-by-step illustrations are provided by Sika.

Welding the Sika® SolarClick fasteners is the most demanding work step. The Sika registered or certified contractor that installed the roof system may also weld the Sika® SolarClick elements to the roof membrane. This allows the warranty to be provided by a single company, which is an additional benefit for the roof owner.

Sika® SolarClick fasteners are welded to the membrane with standard equipment and welding parameters, the same as for the respective Sika® roofing membrane. Welding can be done manually or with a semi-automatic welder. The installation of the Sika® SolarMount-1 system does not require any roof membrane penetrations or the use of slip sheets.



Preparation of system components on a workbench



Hot-air welding of a Sika® SolarClick flange



Installation in progress

# PV CONCEPTS & BUSINESS MODELS

## A RANGE OF OPTIONS TO MEET EVERY OWNER'S NEEDS AND EXPECTATIONS

Since the PV boom began in 2005, much has changed regarding PV concepts and business models. So-called feed-in tariffs and subsidies for energy sold to power companies were originally high and made for fast growth of this young industrial sector. But today such tariffs and subsidies are either low or have disappeared altogether. Market growth is now being driven by the economics of PV power generation and the ambition of companies to reduce their CO<sub>2</sub> footprints.

### **Private financing and consumption**

Under this financing scheme, the system owner, who is typically also the power consumer, uses their own funds to pay for the system. Over the past ten years of PV development (at least in Europe), much of which has been driven by support schemes, this has been the most common financing scheme in the smaller-scale residential and commercial segments. A key benefit is the short payback period for the investment.

It is important not to rely exclusively on this model, however, as private funding limits PV projects to sites with owners who have sufficient funds available. Thus, other financial models have been developed in order to expand the potential beyond private financing. Among the other common concepts and business models, these two have also been in use for many years:

### **Power purchasing agreement (PPA)**

A power purchasing agreement is a purchasing contract between an electricity provider and a consumer, with a predefined price rate per kWh for an extended term (10-25 years).

The PV plant operator typically sets up a special purpose vehicle (SPV). The power consumer (or consumers) then signs a contract with the operator for the supply of electricity. The operator SPV contracts with the O&M service provider, the grid operator/utility to sell excess electricity, the EPC for construction, and the bank and equity providers for financing.

Price rates under the PPA can be set in several ways:

- A fixed rate for the duration of the contract
- An initial rate with an annual price adjustment clause
- A dynamic discount on the retail electricity rate; the higher the rate increase, the greater the discount

### **Leasing**

Leasing is a financing scheme for owners/tenants who either don't want to have the PV system on their balance sheet or don't have the funds available but still want to benefit from their own power generation and consumption. The solar leasing company designs, purchases, and installs a PV system on the consumer's roof and receives a monthly rental payment or leasing fee over a long period of time (10-20 years). Most contracts include an option to buy the system at the end of the leasing term.

Like other financing schemes, the leasing model avoids the up-front costs that often prohibit the installation of PV systems and it spreads the ownership expenses over a long period of time.

Sources: Solar Power Europe, "EU-WIDE SOLAR PV BUSINESS MODELS", November 2016  
Horvath D., Zsabo R.: "Evolution of PV business models: Overcoming the main barriers of distributed energy deployment", 2018



# GLOBAL EXPERIENCE

OVER 600 Sika® SolarMount-1 PV PLANTS ARE IN SERVICE WORLDWIDE

The SSM1 installation track record is impressive: In international collaboration with the PV company Centroplan GmbH, over 600 Sika® SolarMount-1 plants have been installed over Sika roofing membranes since 2013<sup>\*)</sup>.

<sup>\*)</sup> as of early 2019

**SSM1 plants have been installed on 3 continents:**

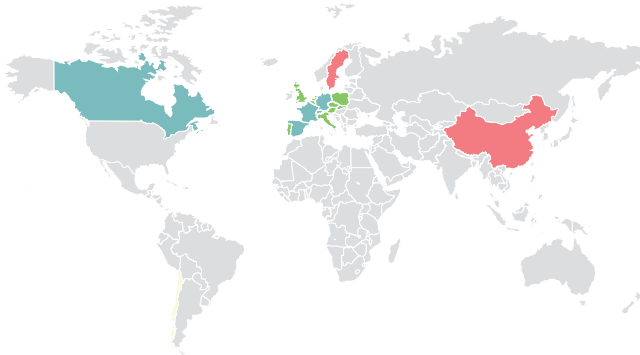

**Sika SSM1 demo installations**



**Examples illustrating the versatility of SSM1 in terms of membranes and substrates**





# PROJECT MANAGEMENT & BENEFITS

## PROVEN CONCEPT – PEACE OF MIND

Sika SolaRoof® is a proven concept for realizing secure, durable, lightweight PV roofs. Thanks to reliable project management, integrated design, and installation by experienced roofing contractors, the concept delivers a range of benefits that deliver added value for the roof owner.

### Roles and responsibilities of the players in a Sika SolaRoof® project

Thanks to the long-term collaboration between Sika and Centroplan and the experience gained through a large number of successfully completed projects, project management is defined and proven. Notwithstanding, the installation of SSM1 and the electrical components can always be readily adapted to suit the local conditions.

PV service provider	Centroplan GmbH	<ul style="list-style-type: none"> <li>■ Professional photovoltaic system design (wind load calculations, layout, etc.)</li> <li>■ Supply of SSM1 (always), PV modules, electric components, electrical planning (optional)</li> <li>■ Warranty management SSM1 (always), warranty management other services (optional)</li> <li>■ PV plant commissioning, network connection, monitoring (optional)</li> </ul>
Roofing system supplier	Sika	<ul style="list-style-type: none"> <li>■ Production and supply of the waterproofing membranes and all required ancillary products and accessories such as vapor control layers and thermal insulation</li> <li>■ Wind load calculations for membrane fastening</li> </ul>
Roof installation	Roofing contractor	<ul style="list-style-type: none"> <li>■ Professional installation of the complete roofing system</li> <li>■ Regular maintenance of the roof under separate agreement</li> <li>■ Sika registered or certified company</li> </ul>
PV system delivery	PV system supplier(s)	<ul style="list-style-type: none"> <li>■ Production and supply of the photovoltaic components (modules, electrical components)</li> <li>■ Issuance of PV module performance guarantees</li> <li>■ Recommended by Centroplan GmbH</li> </ul>
PV system installation	PV installation contractor	<ul style="list-style-type: none"> <li>■ Professional installation of all photovoltaic system components, including SSM1</li> <li>■ Regular maintenance of the PV installation under separate agreement</li> <li>■ Recommended by Sika and Centroplan GmbH</li> </ul>

### Sika SolaRoof® is the complete PV solution delivering significant advantages



**Comprehensive.** Sika membrane and Sika® SolarMount-1 are one integrated and thoroughly tested system



**Stable Position.** Sika® SolarMount-1 is secured directly to the roofing membrane, eliminating the potential for damage



**Non-penetrating.** With the Sika® SolarClick welding flange, there are no penetrations as potential leakage points



**Lightweight.** Ballast is typically not required, making the system ideal for lightweight roof structures



**Versatile.** Sika® SolarMount-1 can be assembled by just a few components in a variety of configurations, with either south or east-west orientations



**Designed.** PV module layout, wind load calculations and financial calculations are provided by trusted partner Centroplan



**Reliability.** Incorporates the proven performance of Sika roof assemblies with the innovative Sika® SolarMount-1 for long-term securement

# GLOBAL BUT LOCAL PARTNERSHIP

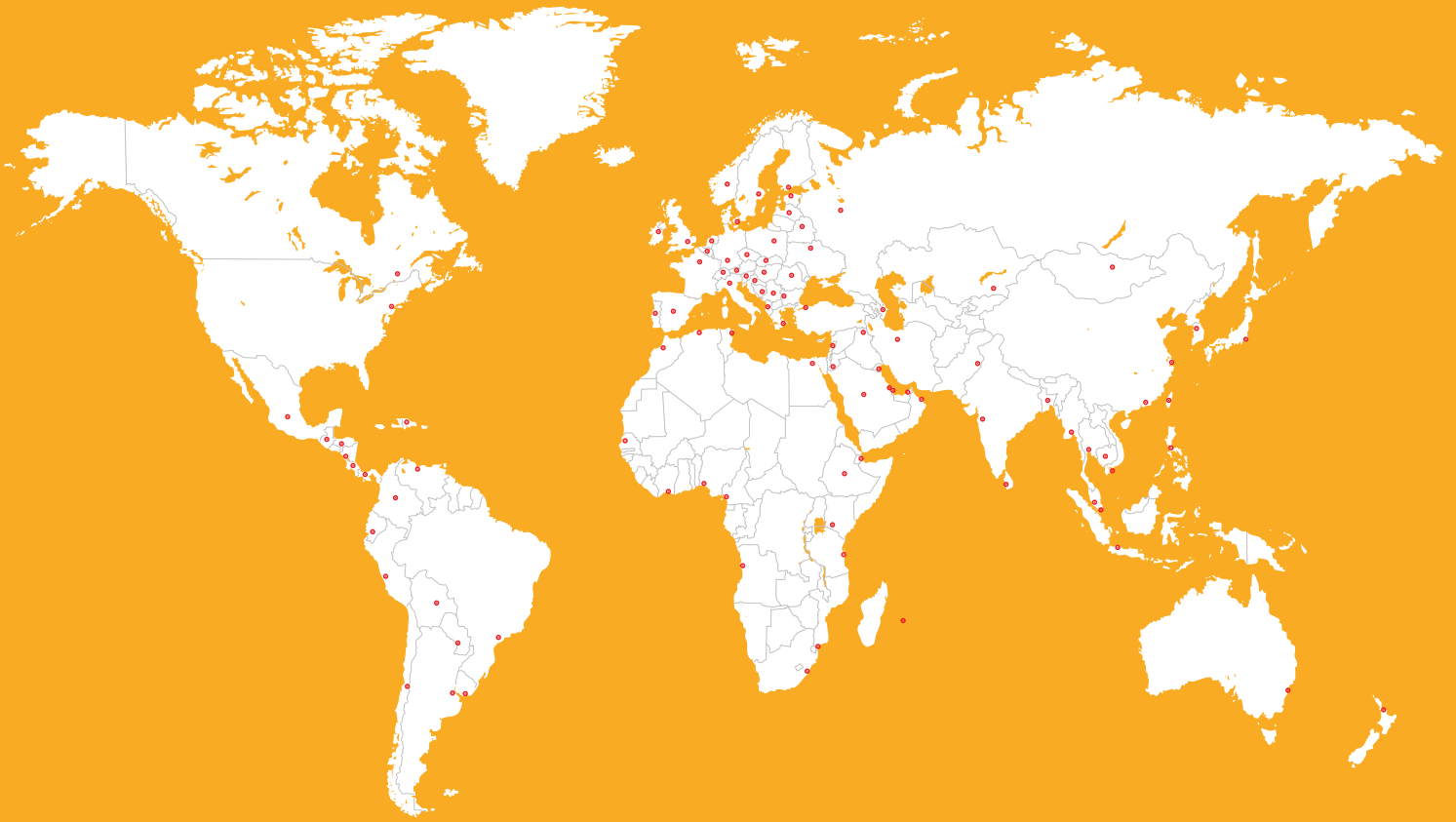

## WE ARE SIKA

Sika is a specialty chemicals company with a leading position in the development and production of systems and products for bonding, sealing, damping, reinforcing and protecting in the building sector and the motor vehicle industry. Sika's product lines feature concrete admixtures, mortars, sealants and adhesives, structural strengthening systems, industrial flooring as well as roofing and waterproofing systems.

Our most current General Sales Conditions shall apply. Please consult the most current local Product Data Sheet prior to any use.



**SIKA SERVICES AG**  
Tueffenwies 16  
CH-8048 Zurich  
Switzerland

**Contact**  
Phone +41 58 436 40 40  
[www.sika.com](http://www.sika.com)

**BUILDING TRUST**

